

# 醫療器材法規簡介及電腦輔助分析於牙科植體應用

## The Application of CAE in Dental Implant and Introduction of Medical Device Regulations

林峻立 特聘教授

國立陽明大學生物醫學工程學系

**Chun-Li Lin, Ph.D.**

**Department of Biomedical Engineering,**

**National Yang-Ming University, Taiwan**

CAEB Lab.Website <http://caeb.tw/>

# Outline

- 醫療器材簡介
- **3C (CAD\CAE\CAM)**
  - Computer Aided Design
  - Computer Aided Engineering
  - Computer Aided Manufacture
- **3R (RE\RP\RT)**
  - Reverse Engineering
  - Rapid Prototyping (3D-printing)
  - Rapid Tooling
- **Medical Device Regulations for Implant**





# 全球醫療器材市場產業概況

單位：億新台幣

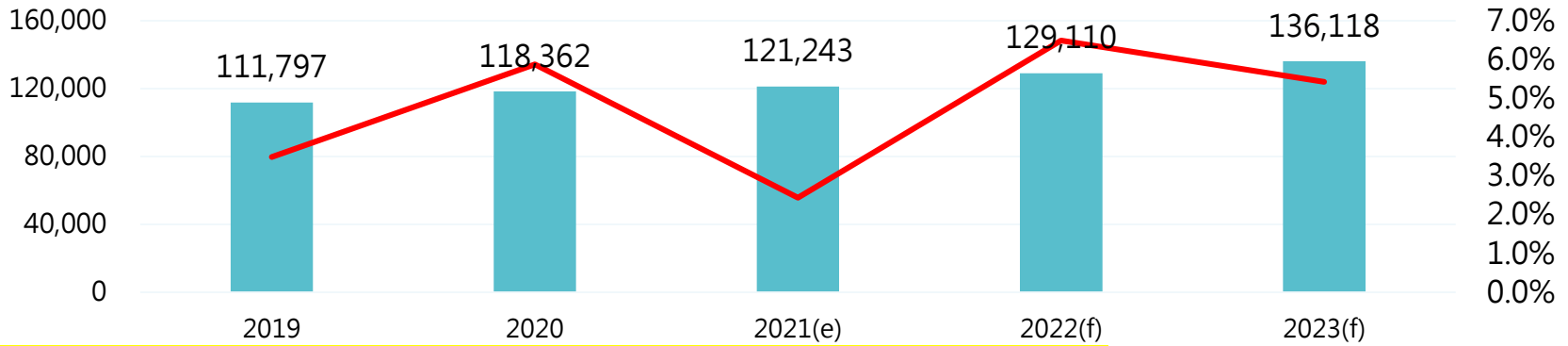

2023年全球醫材市場規模預計可達約13兆餘新臺幣(5000億美金)

市場規模 年成長率

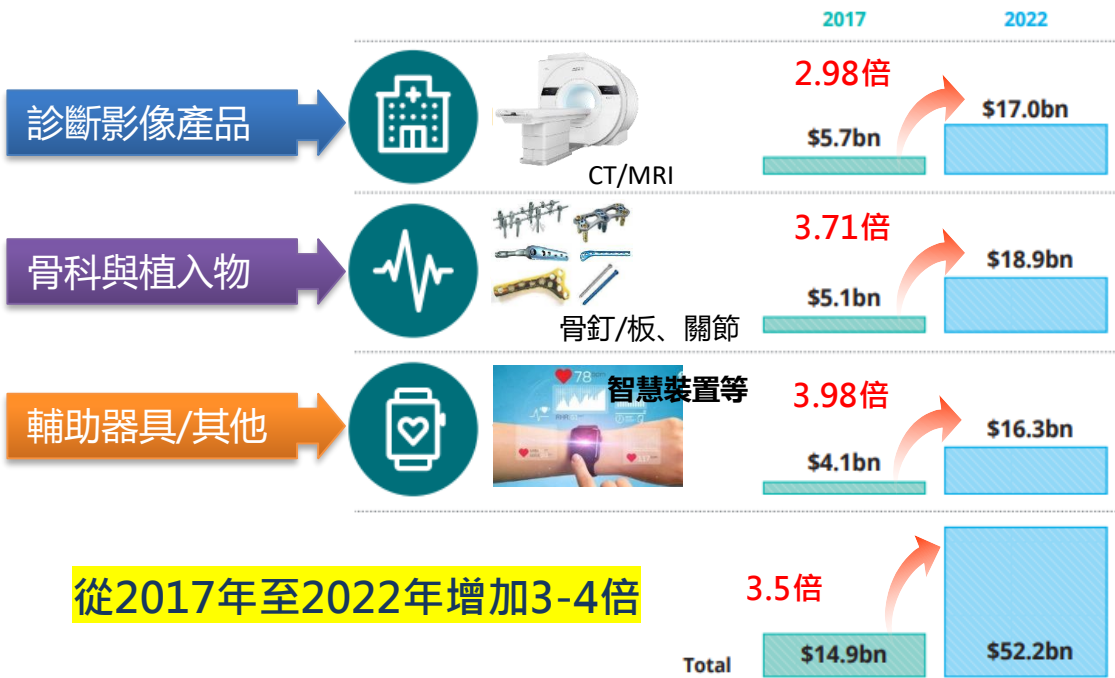
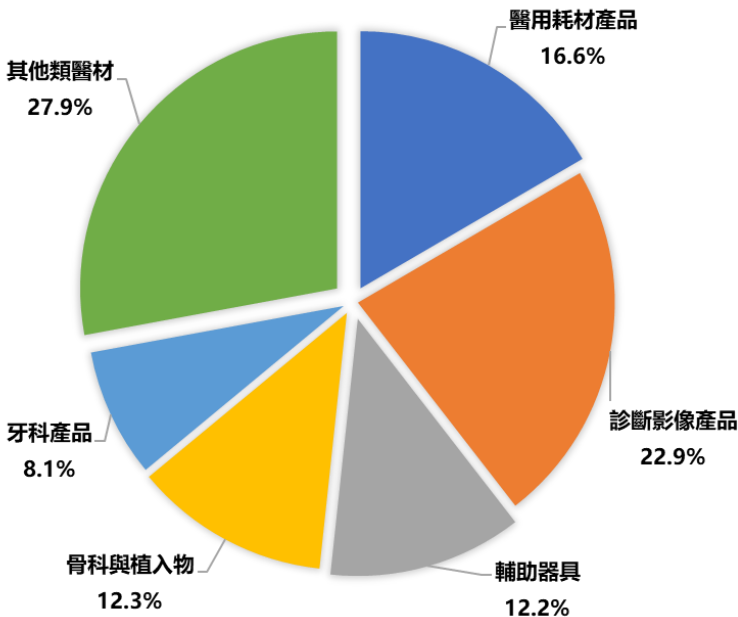

從2017年至2022年增加3-4倍

資料來源：BMI Research(2021/04)；工研院產科國際所(2021/05)



# 台灣醫療器材產業現況

單位：億新台幣

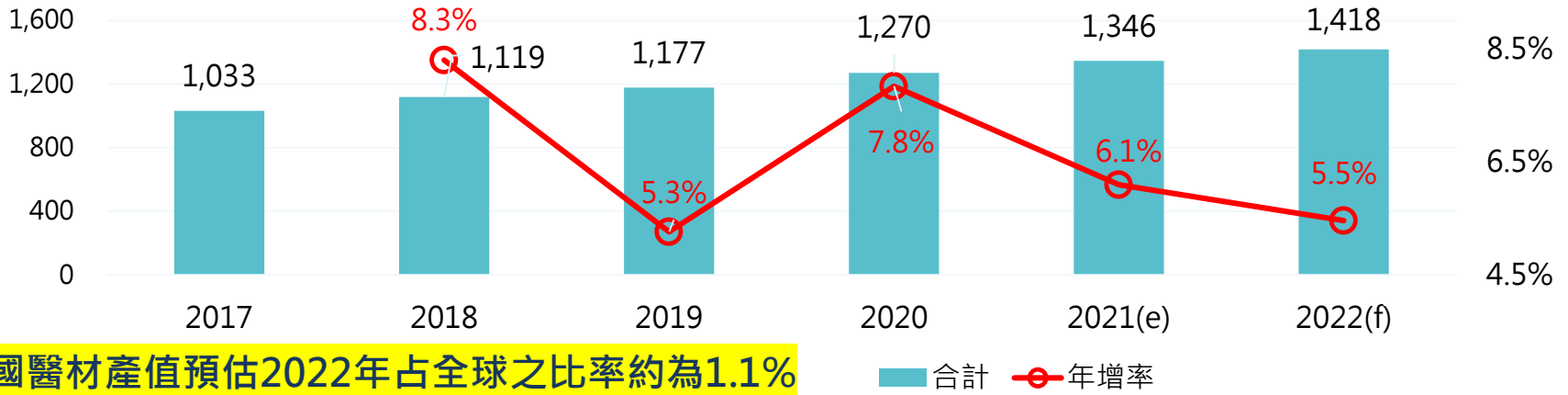

我國醫材產值預估2022年占全球之比率約為1.1%

年度	年度通過張數	未註銷總張數	國產總張數	輸入總張數
2010	3,920	30,140	5,905	24,235
2011	4,047	33,865	6,857	27,008
2012	3,592	32,821	7,057	25,764
2013	3,827	35,705	8,079	27,626
2014	3,605	37,967	8,952	29,015
2015	3,743	40,579	9,678	30,901
2016	3,818	43,328	10,329	32,999
2017	3,940	46,797	11,203	35,594
2018	3,985	45,890	11,172	34,718
2019	3,770	45,839	11,332	34,507

2010年產值662億(24億美元)  
發出5,905張

產值成長1.77倍  
許可證成長1.91倍

2019年產值1,177億(43億美元)  
發出11,332張

2010年到2019年，10年間產值和發放許可證張數皆成長為近2倍

# 台灣生物科技產業現況-多元化發展

## 生技產業範疇

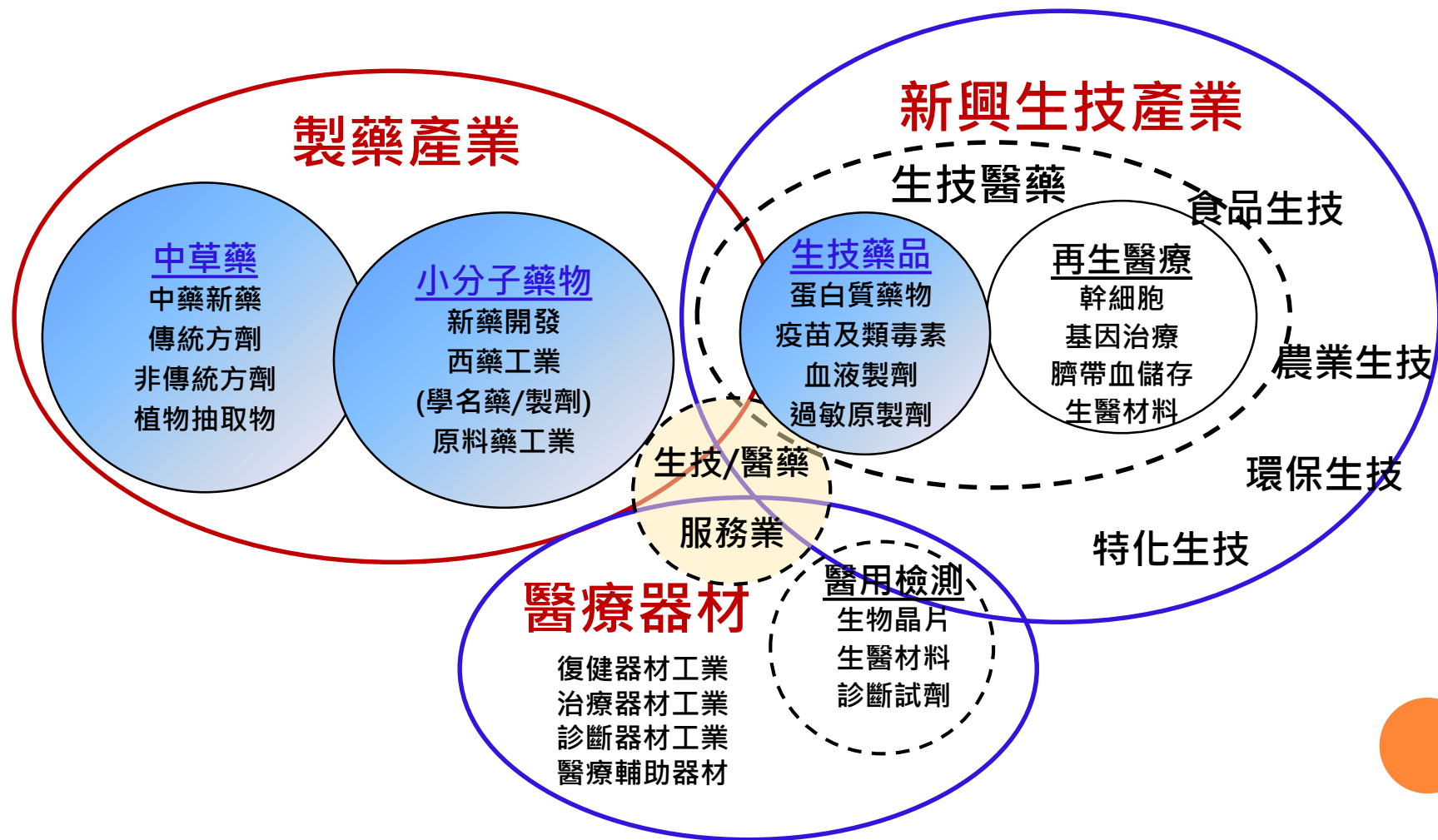

# 全球vs台灣醫療器材市場

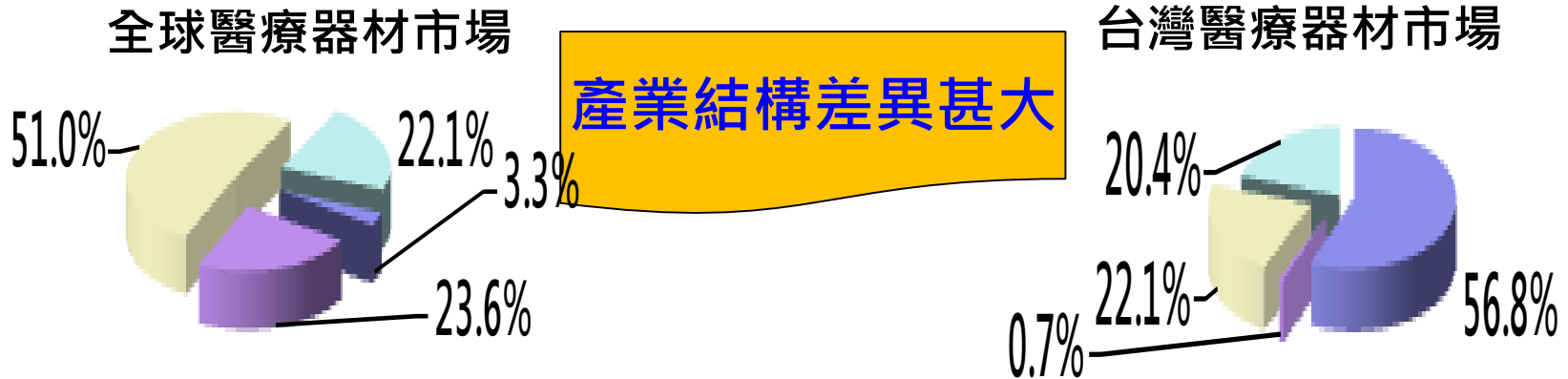

居家用消費型醫材：台灣56.8% vs. 全球 3.3%

醫院用診斷監測設備：台灣0.7% vs. 全球 23.6%

醫院治療用產品：台灣22% vs. 全球 51.0%

- 居家用消費型醫材：輪椅、代步車、血壓計、體溫計、血糖計等。
- 醫院用診斷監測設備：X光儀器設備、心電圖、超音波、MRI、生理監視器等。
- 醫院治療用產品：牙科、眼科與骨科儀器設備、手術器械、骨科與牙科彌補物等。
- 耗材：手套、注射器與導管、急救箱、包紮敷料等。

目前台灣醫材產業，逐漸由居家用醫材，轉換為高階醫材(較高風險)發展，企圖有效提升醫材產值與市場佔有率。

# 法源依據

- 依據「醫療器材管理法」第3條第2項規定。

- 第三條
- 1 本法所稱醫療器材，指儀器、器械、用具、物質、軟體、體外診斷試劑及其相關物品，其設計及使用係以藥理、免疫、代謝或化學以外之方法作用於人體，而達成下列主要功能之一者：
    - 一、診斷、治療、緩解或直接預防人類疾病。
    - 二、調節或改善人體結構及機能。
    - 三、調節生育。
  - 2 **前項醫療器材之分類、風險分級、品項、判定原則及其他相關事項之辦法，由中央主管機關定之。**
  - 3 第一項第二款屬非侵入性、無危害人體健康之虞及使用時毋需醫事人員協助之輔具，得報請中央主管機關核准，免列為前項醫療器材之品項。
  - 4 前項輔具係指協助身心障礙者改善或維護身體功能、構造，促進活動及參與，或便利其照顧者照顧之裝置、設備、儀器及軟體等產品。

- 110年4月26日公告訂定「醫療器材分類分級管理辦法」，全文共7條。

# 醫療器材分類品項



## 醫療器材管理辦法第3條

•醫療器材依據功能、用途、使用方法及工作原理，分17類

- 一、臨床化學及臨床毒理學。
- 二、血液學及病理學。
- 三、免疫學及微生物學。
- 四、麻醉學。
- 五、心臟血管醫學。
- 六、牙科學。
- 七、耳鼻喉科學。
- 八、胃腸病科學及泌尿科學。
- 九、一般及整形外科手術。

- 十、一般醫院及個人使用裝置。
- 十一、神經科學。
- 十二、婦產科學。
- 十三、眼科學。
- 十四、骨科學。
- 十五、物理醫學科學。
- 十六、放射學科學。
- 十七、其他經中央衛生主管機關認定者。

•前項醫療器材之分類分級品項如附件一。

# 醫療器材分類分級 / 風險

	台灣	美國	歐盟 (GHTF)	中國
範圍	試劑+儀器	試劑+儀器	試劑+儀器	試劑+儀器
分類	Class1 ↓ 低 Class2 Class3 ↓ 高	Class1 ↓ 低 Class2(510k) ↓ Class3 ↓ 高	List A ↑ 高 List B Self-test other ↑ 低	Class1 ↓ 低 Class2 Class3 ↓ 高
主管	TFDA	FDA	CA	SFDA
審查	TFDA(ITIR)	FDA Accerdited person	Notified body	C1市級 C2省級 C3國家級 境外 國家級
發證	TFDA	FDA	Notified body	C1市級 C2省級 C3國家級 境外 國家級

# 台灣醫療器材分類分級



**醫療器材管理辦法第2條** 醫療器材字號：衛部醫器製壹字第005

▶ 醫療器材依據風險程度，分成下列等級：

第一等級：低風險性。

第二等級：中風險性。

第三等級：高風險性。

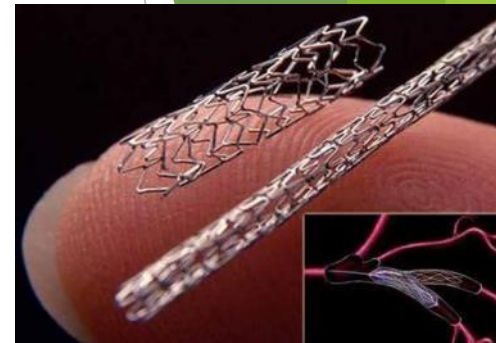

## Class I

- 如手動聽診器、醫用口罩、紗布、一般手術手動器械、彈性繃帶、壓舌板、機械式輪椅、矯正鏡片

## Class II

- 如衛生套、衛生棉條、輸液幫浦、靜電器(電位治療器)、動力式輪椅、軟式隱形眼鏡及其保存用產品、注射針筒/針頭、血糖機、血壓計、電子體溫計、磁振診斷裝置、外科及皮膚科用雷射儀、電子聽診器

## Class III

- 如心臟瓣膜置換物、人工水晶體、眼科用準分子雷射系統、冠狀動脈支架、心律調節器、人工牙根、玻尿酸植入物

# 醫療器材內容與查詢

## 西藥、醫療器材、化粧品許可證查詢

[詳細處方成分](#) | [藥物外觀](#) | [仿單/外盒資料](#) | [授權使用](#) | [健保藥價查詢](#) | [離開](#)

### 許可證詳細內容

\*\*\* 衛部醫器輸壹字第016710號 \*\*\*

註銷狀態		註銷日期	
註銷理由		製造許可登錄編號	
有效日期	110/06/28	發證日期	105/06/28
許可證種類	醫器	醫療器材級數	第一等級
舊證字號			
通關簽審文件編號	DHA09401671001		
中文品名	"貝格"法西歐手術導板(未滅菌)		
英文品名	"Bego" VarseoWax Surgical Guide (Non-Sterile)		
效能	限醫療器材管理辦法「牙齒骨內植入物附件(F.3980)」第一等級鑑別範圍。		
醫器規格	空白		
劑型		包裝	
標籤、仿單及包裝加註			
醫器主類別一	F牙科裝置	醫器次類別一	F3980牙齒骨內植
醫器主類別二		醫器次類別二	
醫器主類別三		醫器次類別三	
主成分略述			
限制項目	02輸入		
申請商名稱	620118G125 新丞貿易有限公司		
申請商地址	台北市中正區南昌路1段157號3樓		
<b>主製造廠</b>			
製造廠名稱	M471287000 BEGO Bremer Goldschlagerei-Wilh. Herbst GmbH & Co. KG		
製造廠廠址	Wilhelm-Herbst-Str. 1, 28359 Bremen, Germany		
製造廠公司地址			
製造廠國別	GERMANY	製程	

# 醫療器材分類品項

(共有 1739 筆資料,共分 174 頁,目前在第 1 頁)

序號	分類分級代碼	中文名稱	英文名稱	等級
1	<a href="#">A.0001</a>	苯環利定試驗系統	Phencyclidine test system	2
2	<a href="#">A.0002</a>	臨床化學離子分析儀	Clinical chemistry electrolyte system	1
3	<a href="#">A.1020</a>	酸性磷酸酶(總量或前列腺的)試驗系統	Acid phosphatase (total or prostatic) test system	2
4	<a href="#">A.1025</a>	促腎上腺皮質荷爾蒙試驗系統	Adrenocorticotrophic hormone (ACTH) test system	2
5	<a href="#">A.1030</a>	丙胺酸轉胺酶試驗系統	Alanine amino transferase (ALT/SGPT) test system	1
6	<a href="#">A.1035</a>	白蛋白試驗系統	Albumin test system	2
7	<a href="#">A.1040</a>	醛醇縮合酵素試驗系統	Aldolase test system	1
8	<a href="#">A.1045</a>	醛類脂醇試驗系統	Aldosterone test system	2
9	<a href="#">A.1050</a>	鹼性磷酸酶或同功酶試驗系統	Alkaline phosphatase or isoenzymes test system	2
10	<a href="#">A.1055</a>	新生兒胺基酸、游離肉鹼及醯基肉鹼篩檢用串聯質譜儀系統	Newborn screening test system for amino acids, free carnitine, and acylcarnitines using tandem mass spectrometry.	2

代碼	名稱	鑑別	等級
F.3640	骨內植體 (Endosseous implant)	骨內植體(endosseous implant) - 是由如鈦金屬製成的器材，以手術方式放置於上或下頷牙弓的骨骼內以提供對修復器材，如人工牙齒之支撐及恢復患者的咀嚼功能。	3

# US FDA 分類醫療器材 (Taiwan TFDA)

---

- **Class I:** simple, low risk devices
    - General control to ensure safety and effectiveness
    - Mostly exempt from Premarket Notification [510(k)]
  - **Class II:** more complex, moderate risk devices
    - General control and Special control
    - Require 510(k) → **Substantial Equivalence (as safe and effective as legally marketed device, SE)**
  - **Class III:** most complex, highest risk devices
    - General control
    - Premarket Approval (PMA) → **Safety & Effectiveness**
- 

# Low risk medical device development

## ❖ 口腔開合運動復健器設計開發及臨床測試



顛顎關節障礙

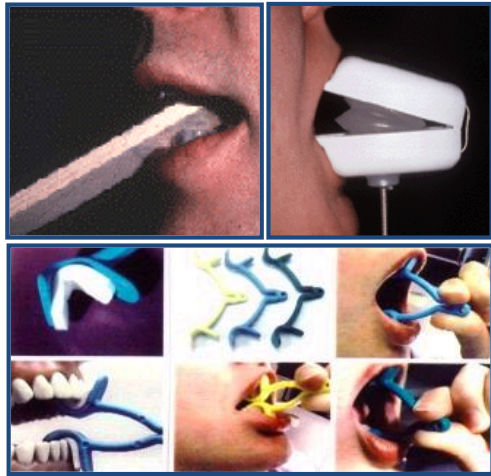

CAD

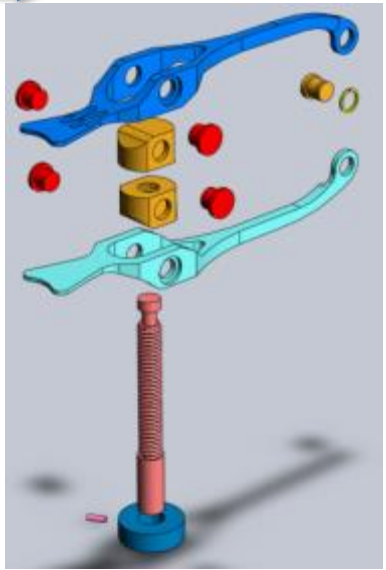
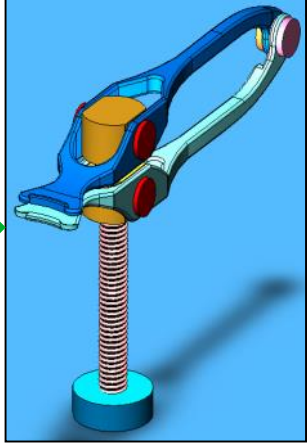

CAM



Clinical Test

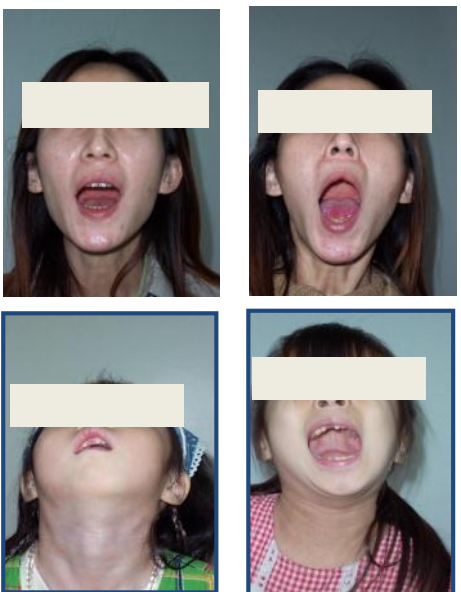

# 3C/3R (CAD/CAM/CAE, RE/RP/RT)

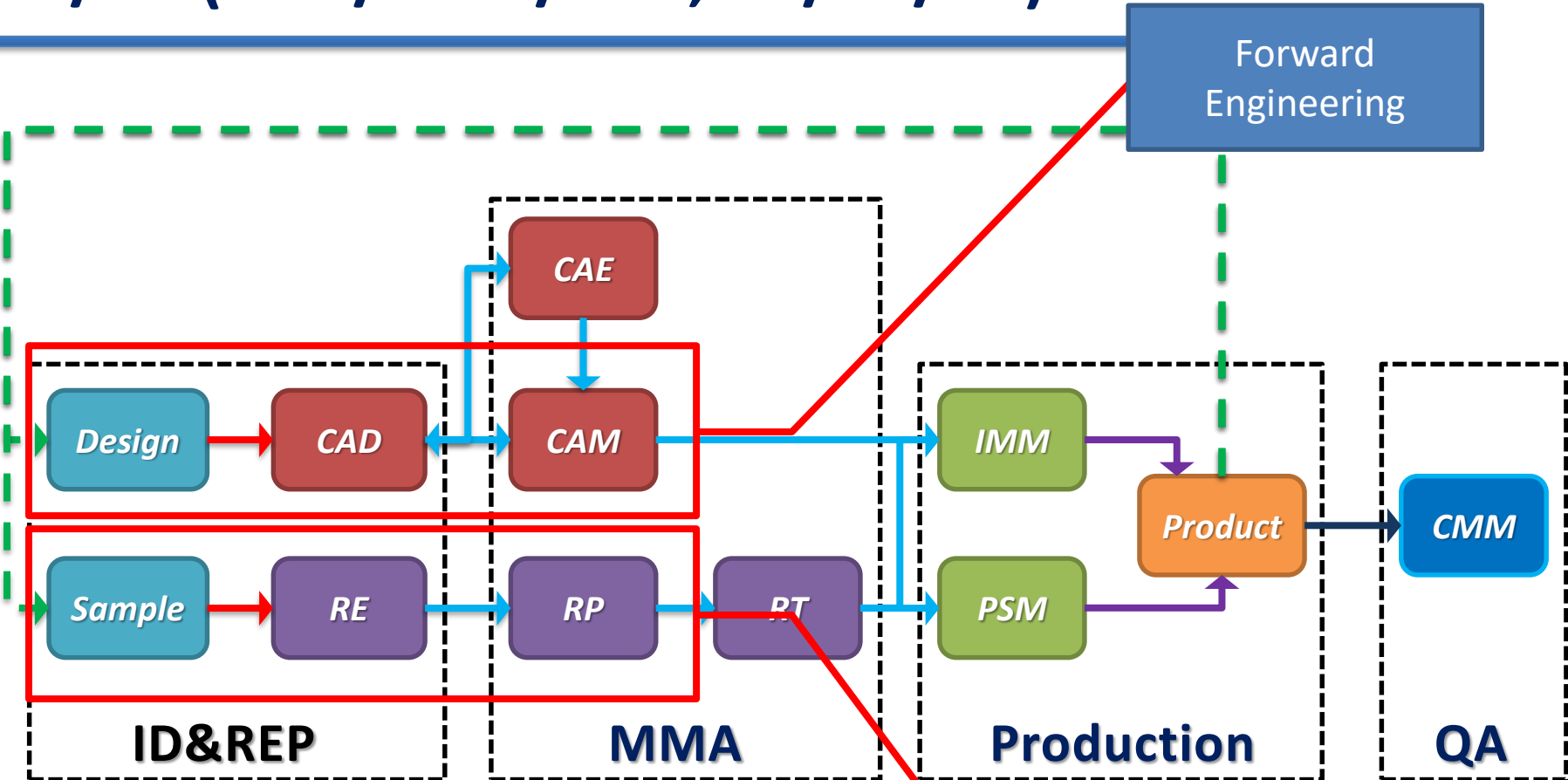

**ID** : Industrial design

**IMM** : Injection mould machine

**QA** : Quality assurance

**MMA** : Mold manufacturing & analysis

**PSM** : Pressing/shearing machine

Reverse Engineering

# CAD/CAM clinical application

## ❖ 下頷角整形手術輔助器具設計

國字臉矯正手術

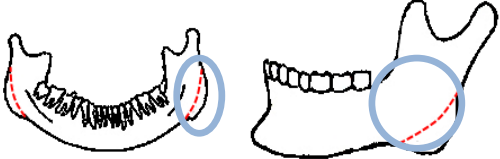
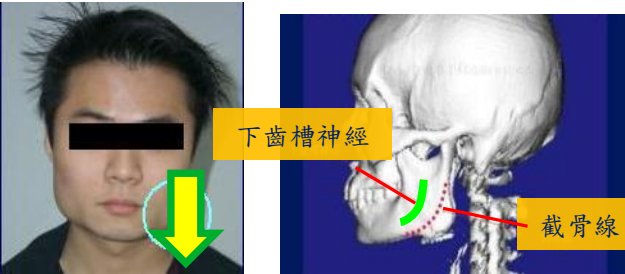

下頷角量測輔助器械

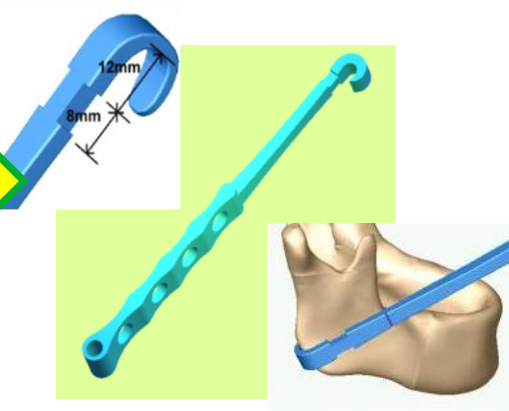

皮膚保護套

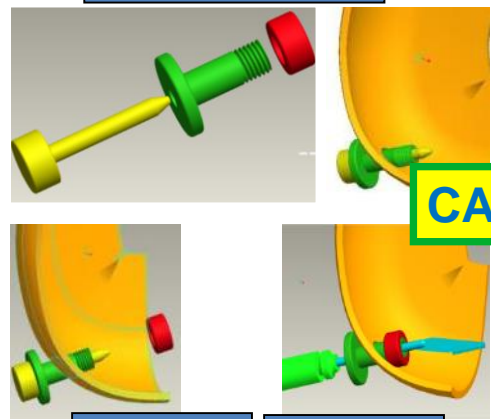

CAM

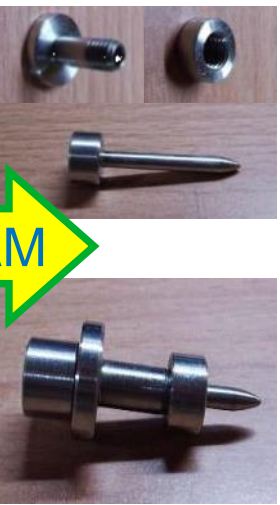

Clinical Test

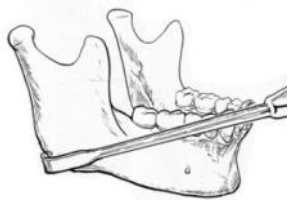

術前

術後

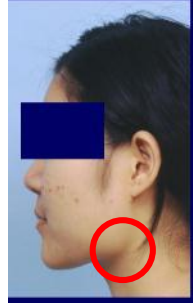

# 3C(CAD/CAM/CAE)

## ❖ 電腦輔助設計 (Computer Aided Design, CAD)

→ 運用工程圖學原理-應用幾何、正投影、剖視圖、尺度標註、公差、表面符號

→ 透過手繪(早期)或電腦軟體製圖 (AutoCAD)

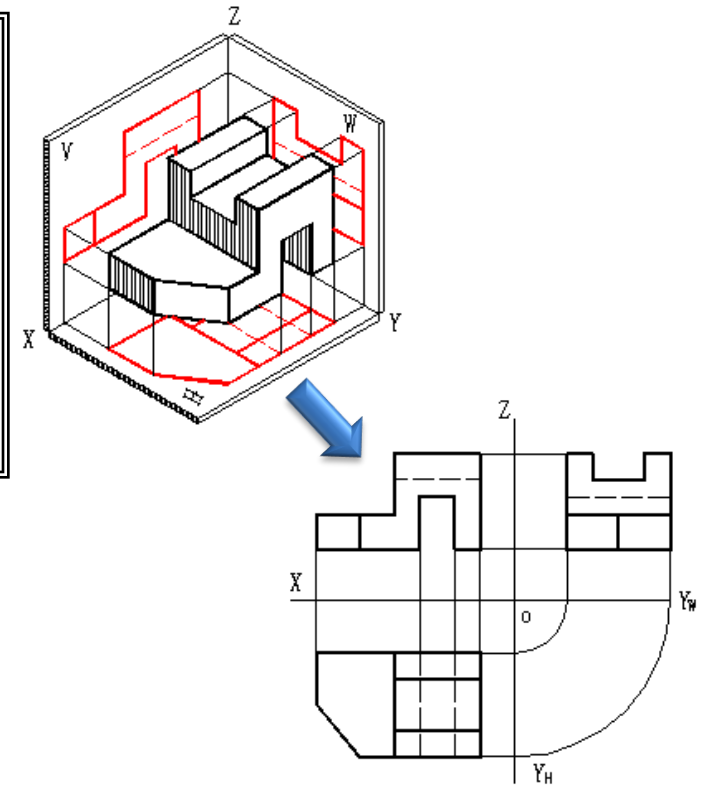
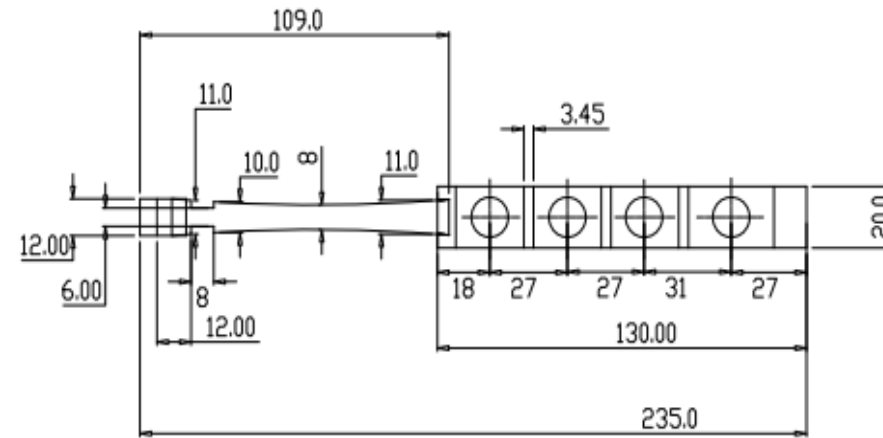

2D三視工程圖





# 3C (CAD/CAM/CAE)

## ❖ 電腦輔助設計 (Computer Aided Design, CAD)

→ 運用 **電腦參數化軟體** 進行實體設計 (Pro/Engineering、Solidworks)

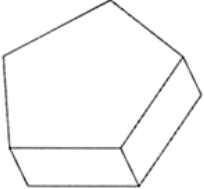
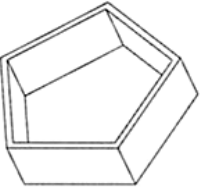
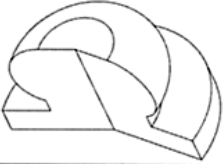
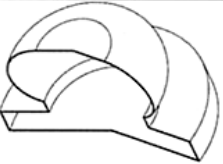
→ 參數化繪圖原理採 “特徵” (Feature) 為基礎之特性，利用一般自然的機械物件之觀念，如 引伸、旋轉、掃描、導圓角、薄殼、鑽孔 等，以最自然的思考方式從事設計工作。擺脫了傳統以點、線、面為主的系統架構，目前的3D CAD系統皆採用 “特徵” 的原則。

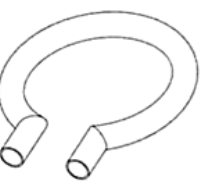
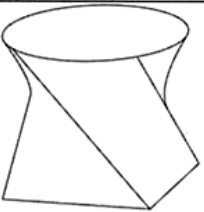
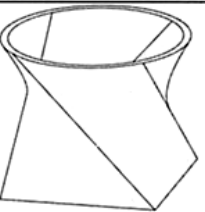
■長肉 (加材料) -Protrusion		
	實體 (Solid)	薄長薄肉 (Thin)
引伸 (Extrude)		
旋轉 (Revolve)		
掃描 (Sweep)		
混合 (Blend)		

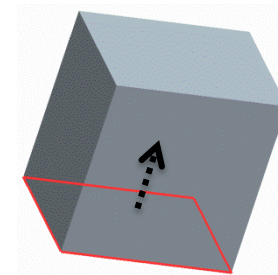

長出

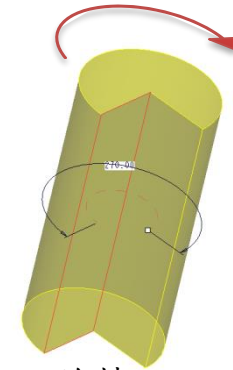

旋轉

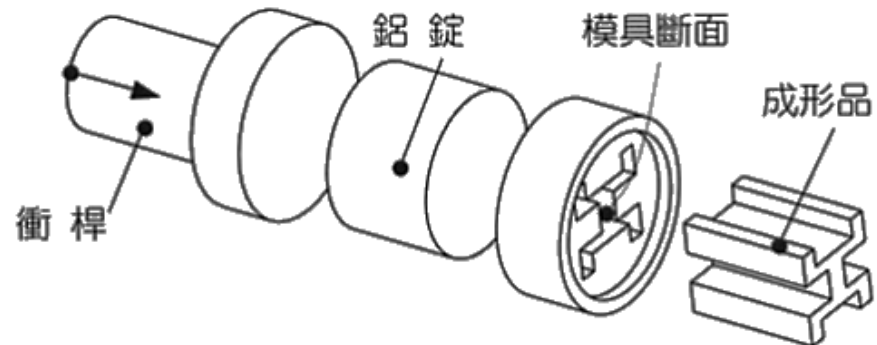

# 3C (CAD/CAM/CAE)

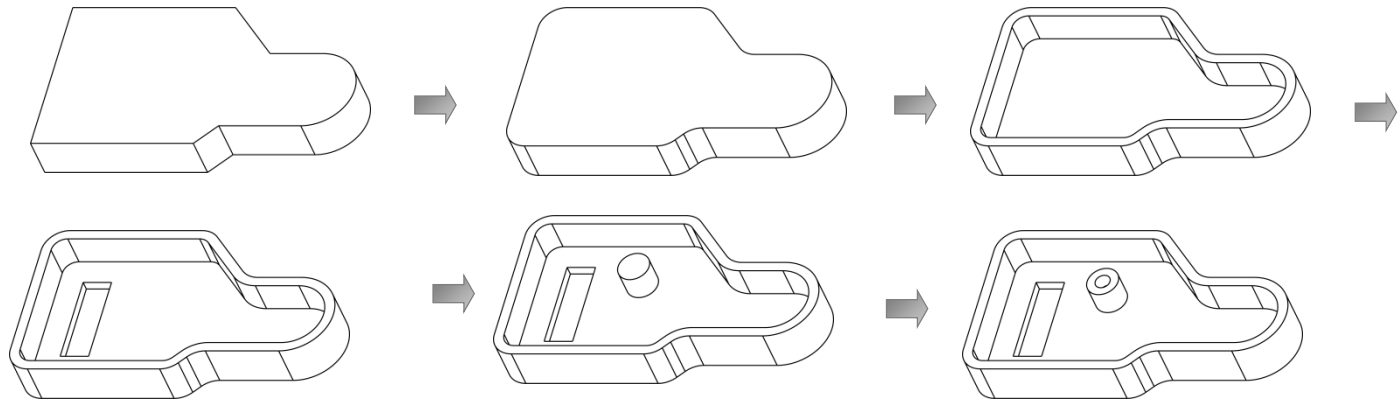

1個「零件」= 特徵1 + 特徵2 + 特徵3 + ... + 特徵N

1個「組立件」= 零件1 + 零件2 + 零件3 + ... + 零件N

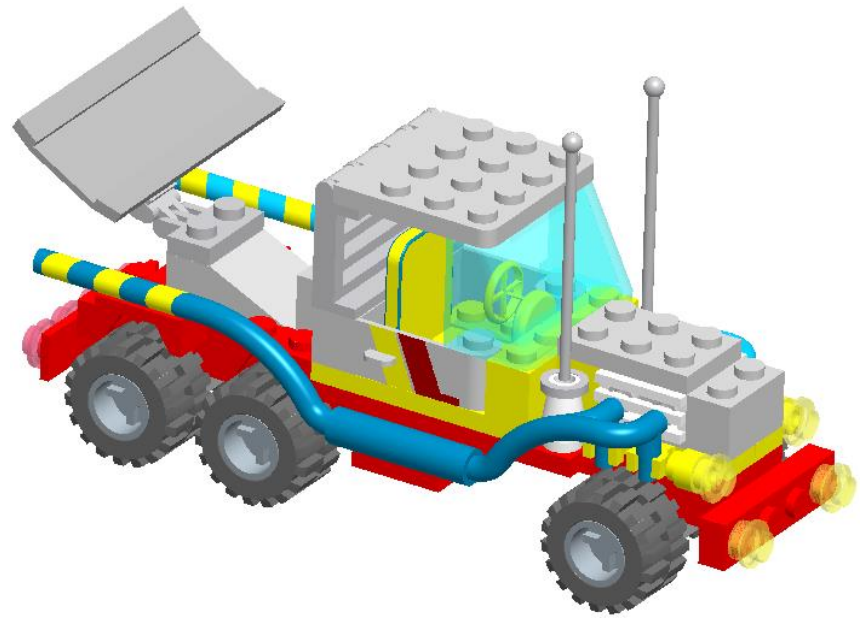
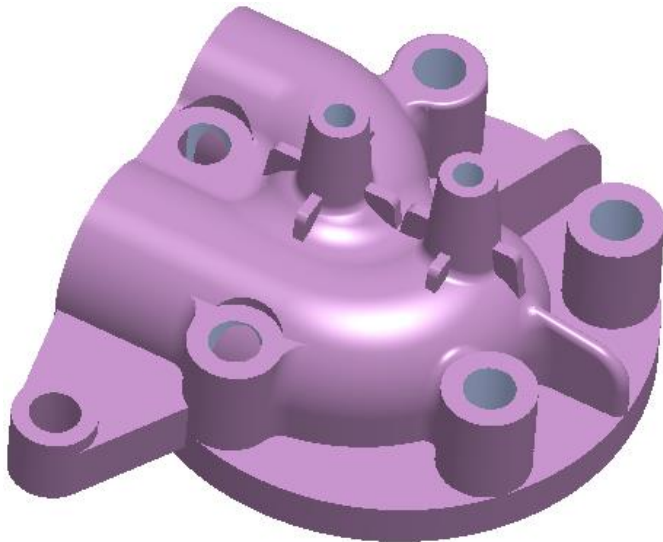

# 3C (CAD/CAM/CAE)

## ❖ 電腦輔助設計 (Computer Aided Design, CAD)

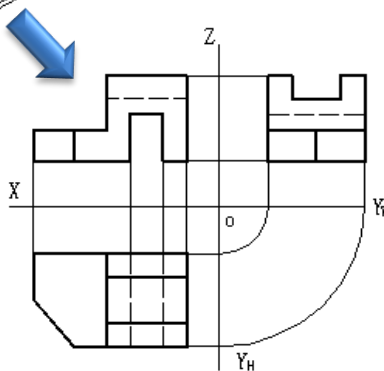
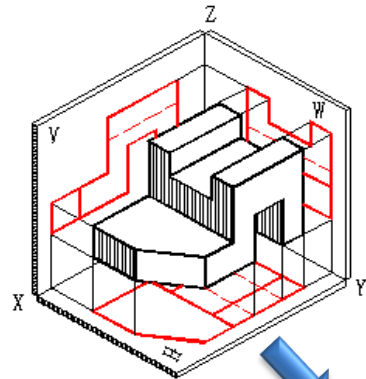
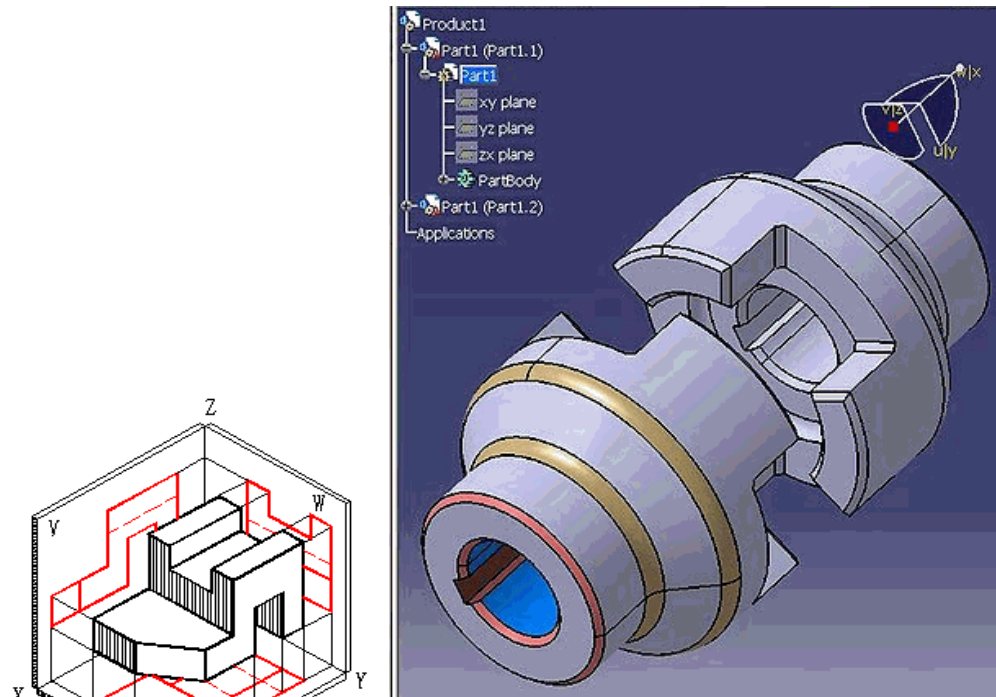

實體/模型

三視工程圖

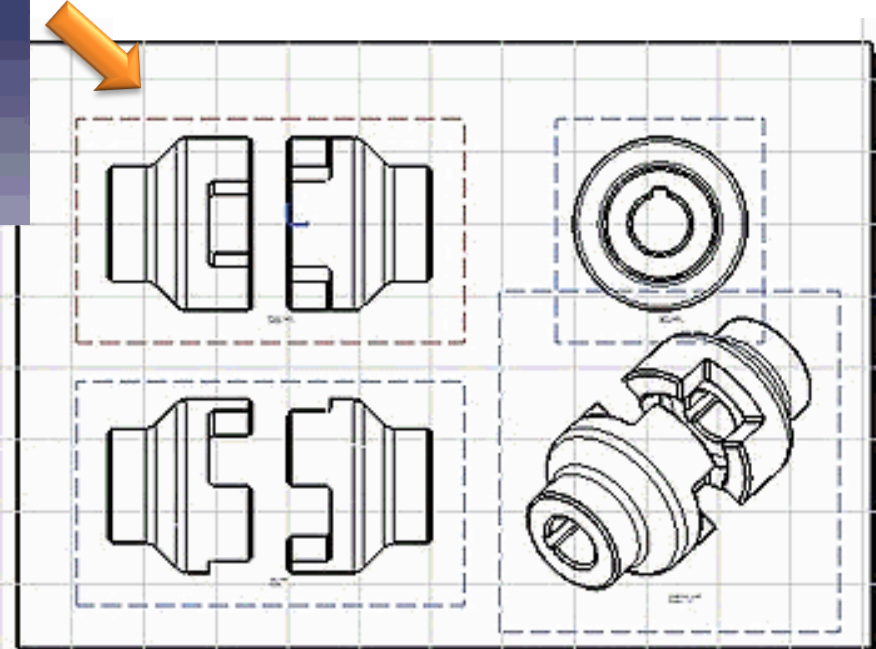
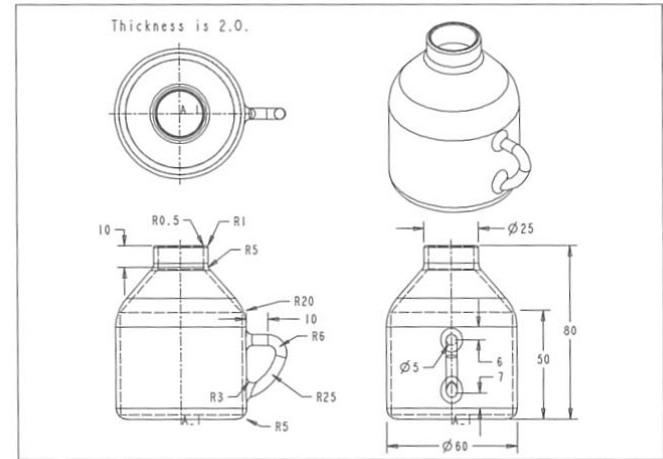

# 3C (CAD/CAM/CAE)

- ❖ 電腦輔助設計 (Computer Aided Design, CAD)
- ❖ 機構設計原理

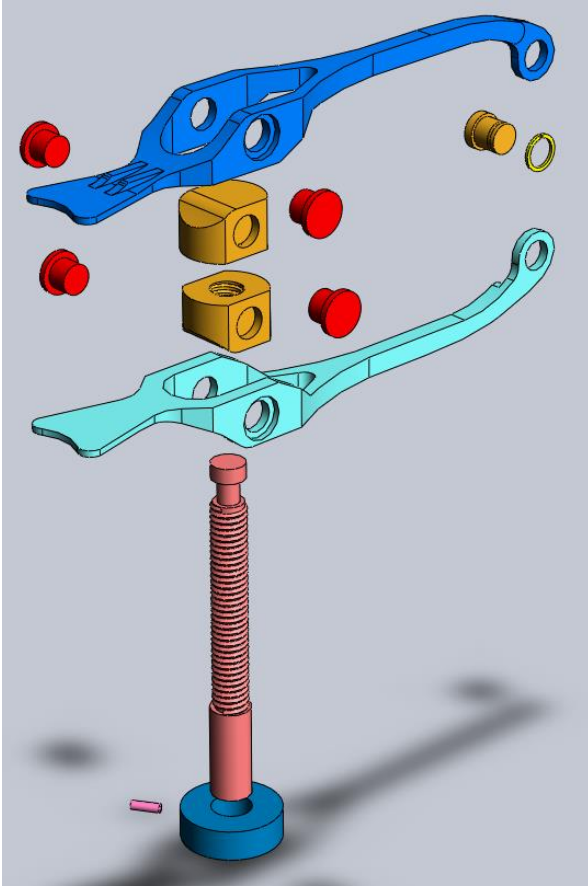

3D 模型繪圖

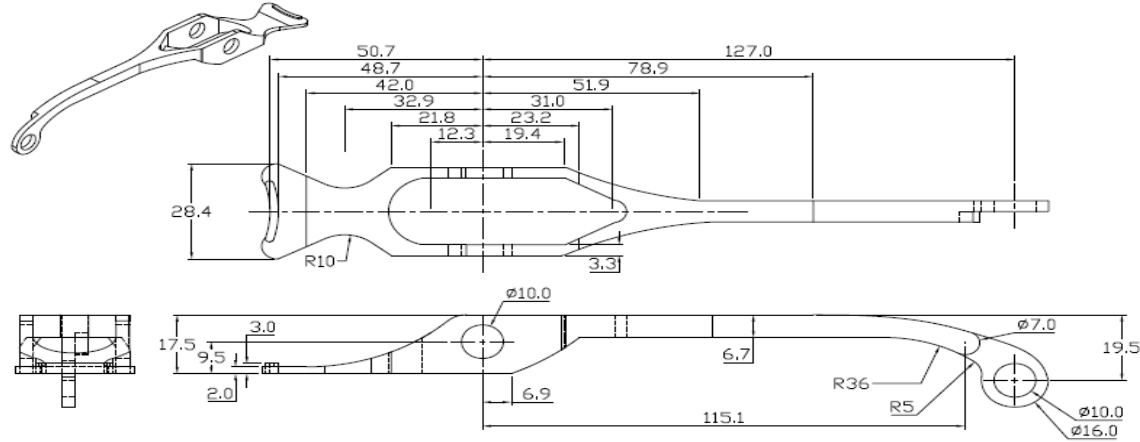

2D三視工程圖



衛署衛署醫器製壹字第003944  
 世亨科技股份有限公司 (02)-29



# 行政院衛生署第一等級醫療器材許可證

醫療器材製壹字第 003944 號

中文名稱：「世亨」一般手術用手術器具組(非滅菌)

英文名稱："SHIH HENG" Manual Surgical Instrument for General Use(Non-Sterile)

類別：第1類：一般及醫用外科手術器具

廠商名稱：世亨科技股份有限公司

規格：空白

製造廠名稱：世亨科技股份有限公司

製造廠地址：新北市新莊區福營路145巷25號

效能：照醫療器材管理辦法「一般手術用手術器具組(400)」第一等級組別規定。  
 處方：空白。

前項醫療器材經本署審核與醫事法之規定相符應發給許可證以資證明

行政院衛生署署長



邱文達

發證日期 中華民國 年 月 日  
 有效日期 中華民國 年 月 日

核准日期				
核准地點				
核准人員				
核准機關				

# CAD/CAM clinical application

## ❖ 仰躺式肘關節手術輔助器械之設計與開發手肘



雛形  
機構  
設計

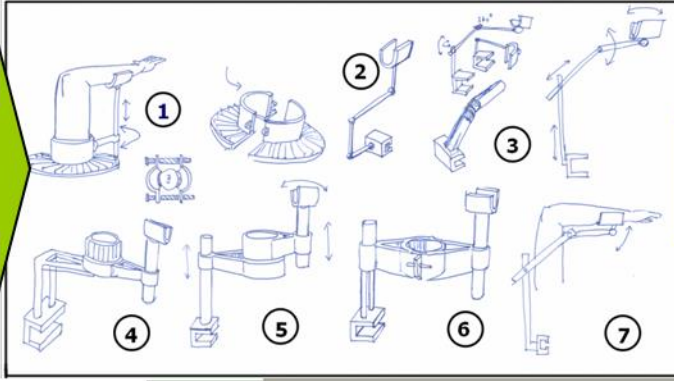

可行  
方案  
整合

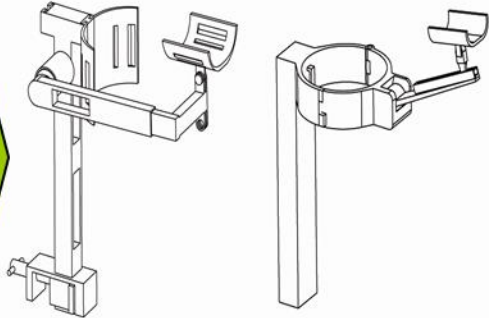

CAD  
及  
動畫  
模擬

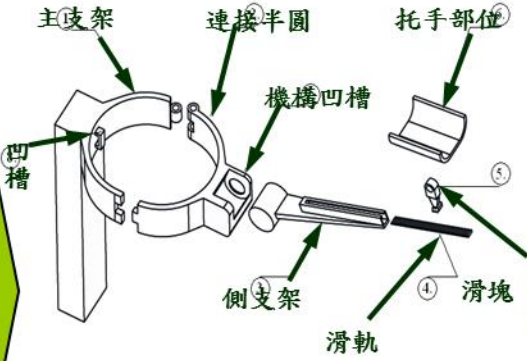

機構  
模擬

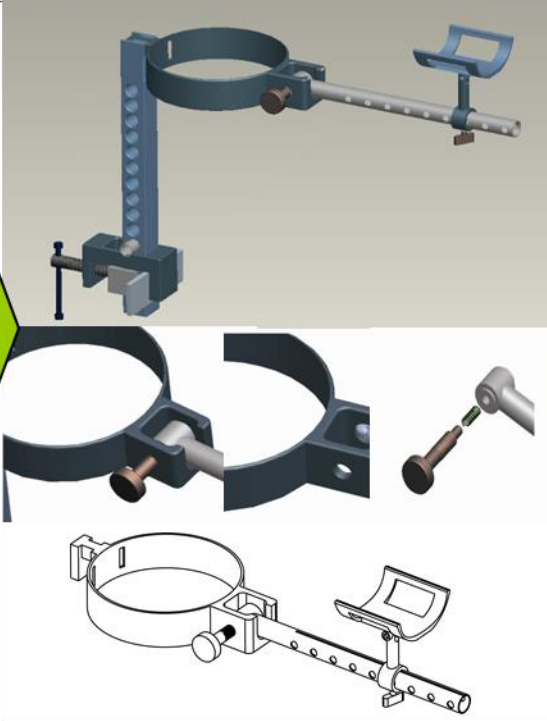

CAM  
及  
臨床  
測試

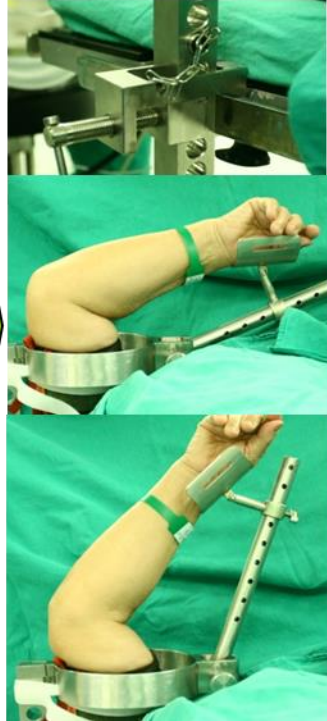

# 3C (CAD/CAM/CAE)

❖ 電腦輔助製造 CAM (Computer Aided Design)

❖ CNC車銑床、複合切削機(3, 4, 5, 6軸)、精度

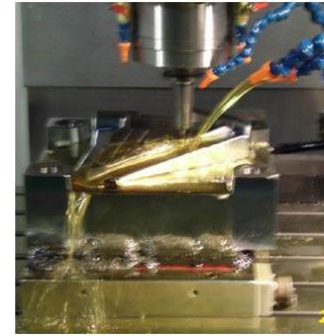
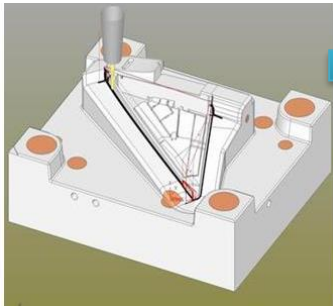

電腦製造路徑規劃

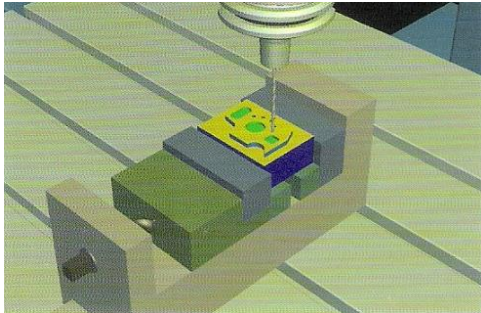

工具機



# 3C (CAD/CAM/CAE)

❖ 電腦輔助製造 CAM

❖ CEREC (CAD/CAM)

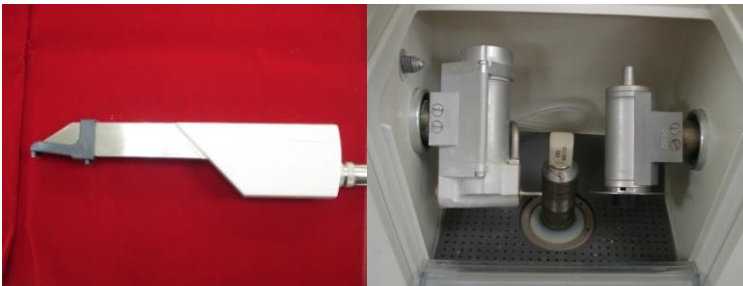
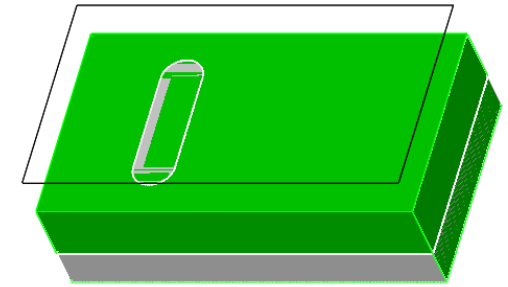

# Dental Biomechanics



Orthodontic mini screw

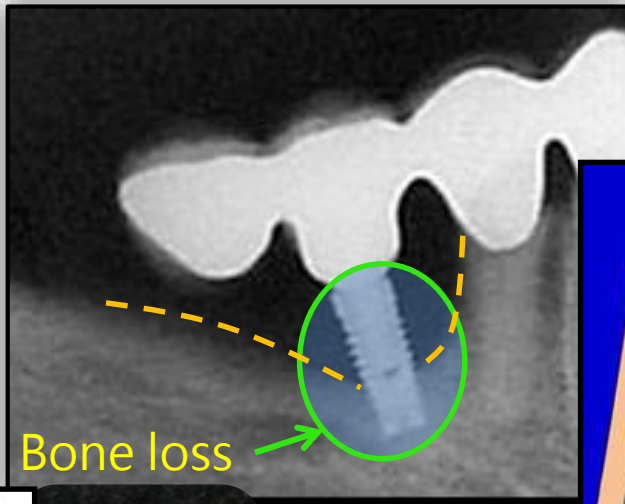

Bone loss

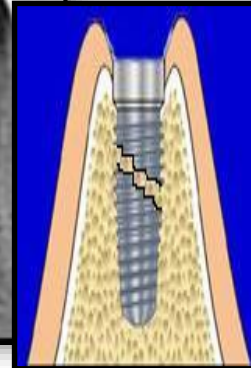

Dental implant

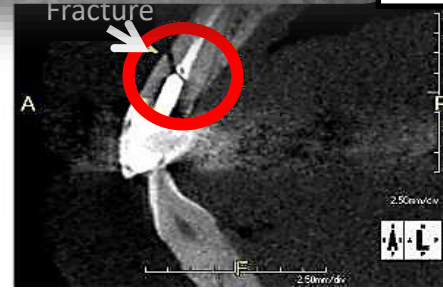
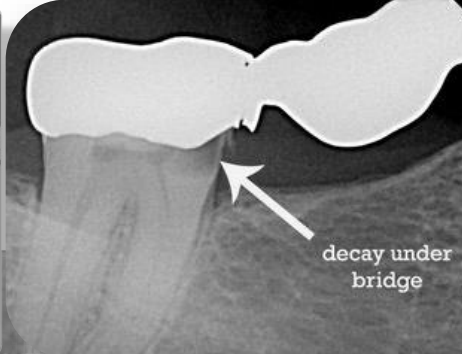

OD & Prosthetic

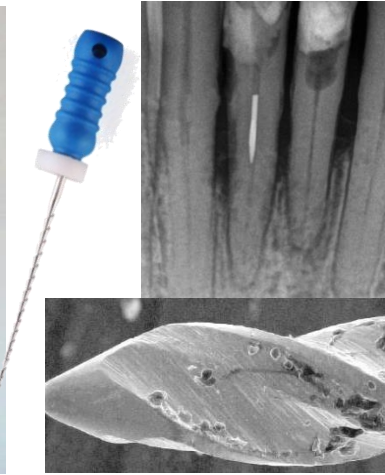
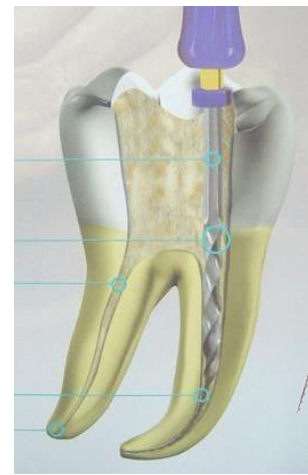

Endodontic

# 3C/3R (CAD/CAM/CAE, RE/RP/RT)

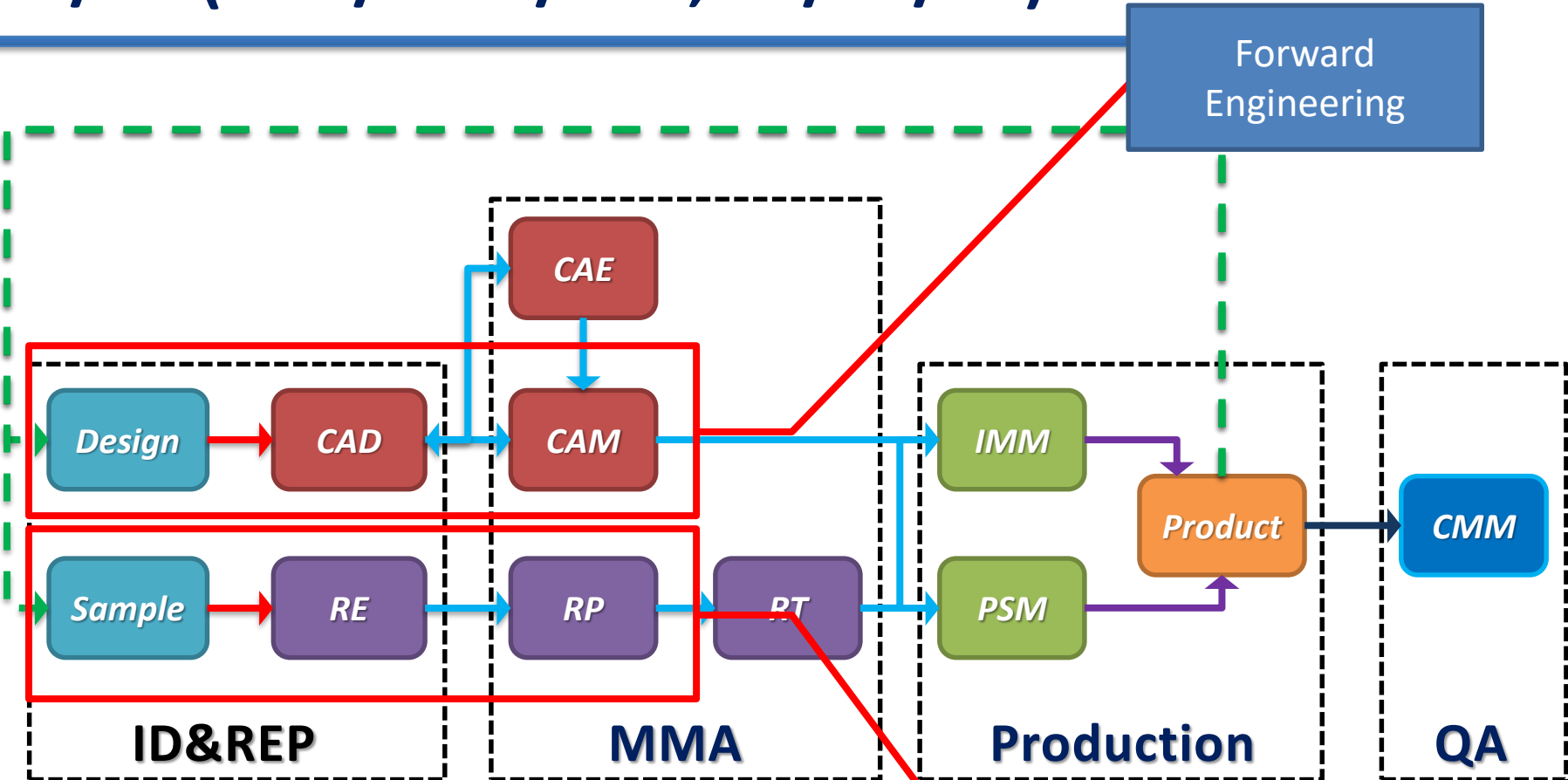

**ID** : Industrial design

**IMM** : Injection mould machine

**QA** : Quality assurance

**MMA** : Mold manufacturing & analysis

**PSM** : Pressing/shearing machine

Reverse Engineering

# Computer aided engineering (CAE)

- Biological and engineering aspects are suitable but difficult to evaluate by experimental techniques
  - limited information
    - stress, strain, energy, etc.*
  - variation within samples
    - size, age, biochemical, morphologic, etc.*
- Relevant biomechanical rationales still unclear

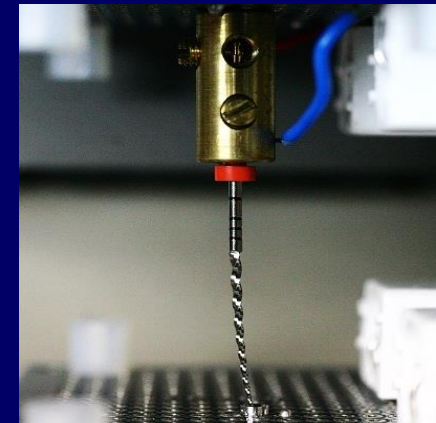
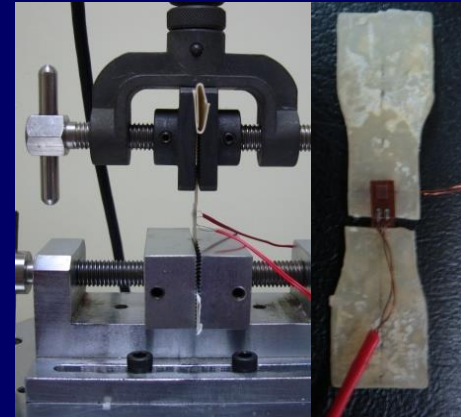
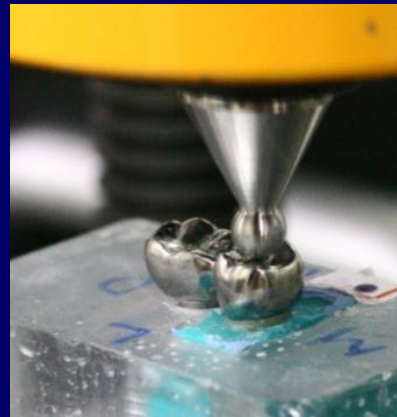
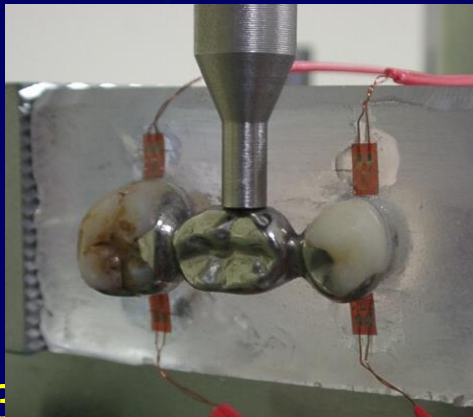

# Computer Aided Engineering (CAE)

❖ 電腦輔助工程 (Computer Aided Engineering, CAE)

## 傳統工程分析

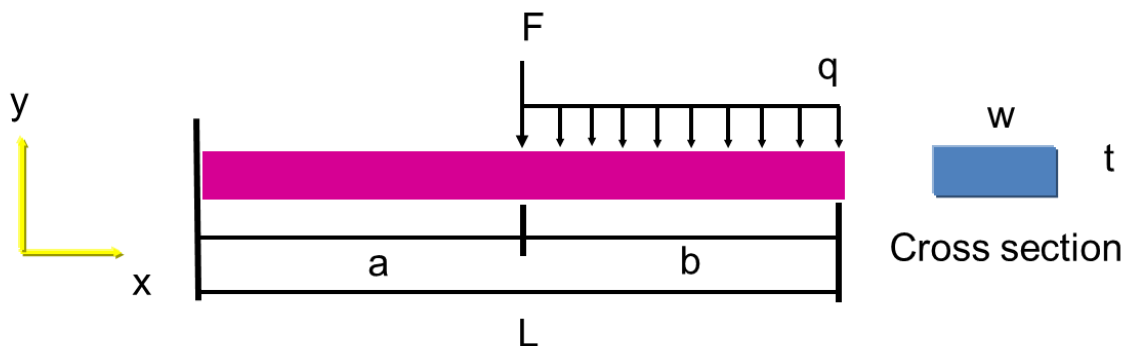
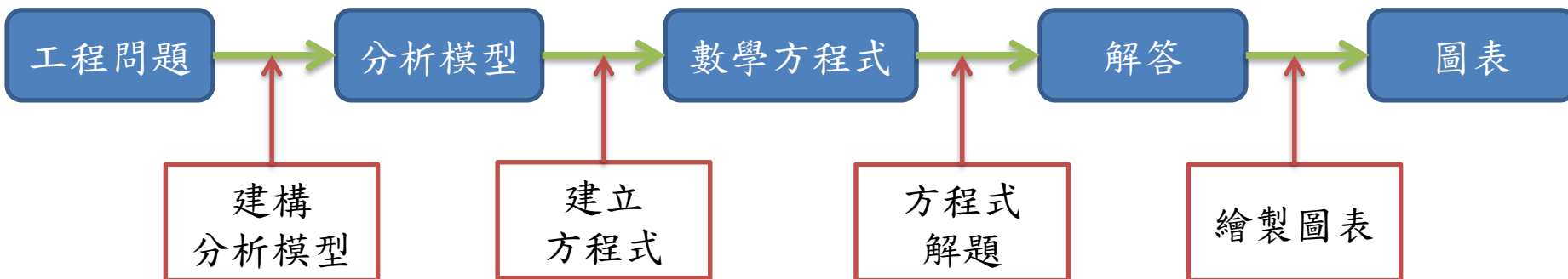

$$y = Fa^3(3L-a)/6EI + q(3L^4 - 4a^3L + a^4)/24EI$$

Analytical analysis



Experimental approach

# Computer aided engineering (CAE)

## ■ Fundamental concepts in FEM

- 實際的物理問題很難利用單一的微分方程式描述，更無法順利求其解析解(analytical solution)
- 有限元素法的精神是將複雜的幾何外型的結構物體切割成許多簡單的幾何形狀稱之為元素(element)
- 元素與元素間以“節點”(node)相連
- 由於元素是簡單的幾何形狀，可順利寫出元素的力平衡方程式並求得節點上之變位、應變及應力等
- 藉由內插法求得元素內任意點的變位、應變及應力等

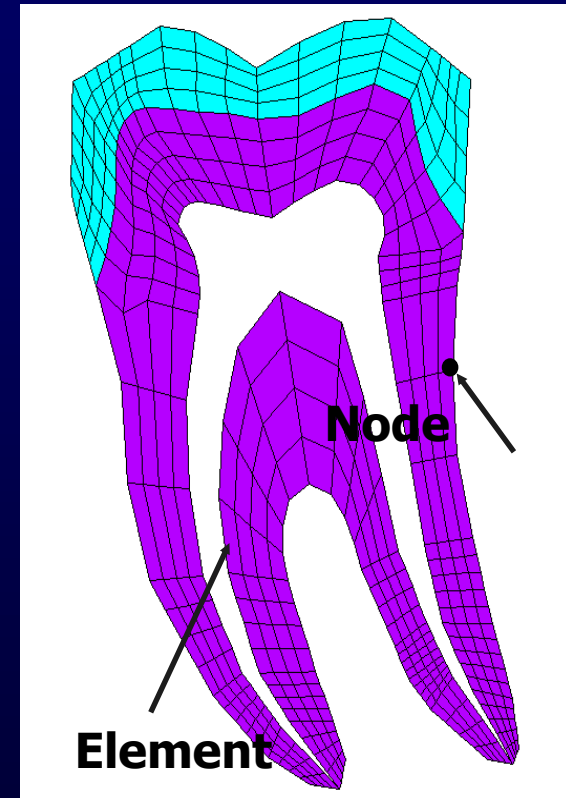

# Computer Aided Engineering (CAE)

## ■ Pre-processing

- Geometry
- Mesh (Element type)
- Materials
- Boundary and loading conditions

## ■ Solution

## ■ Post-processing

- Present the results by graphs...

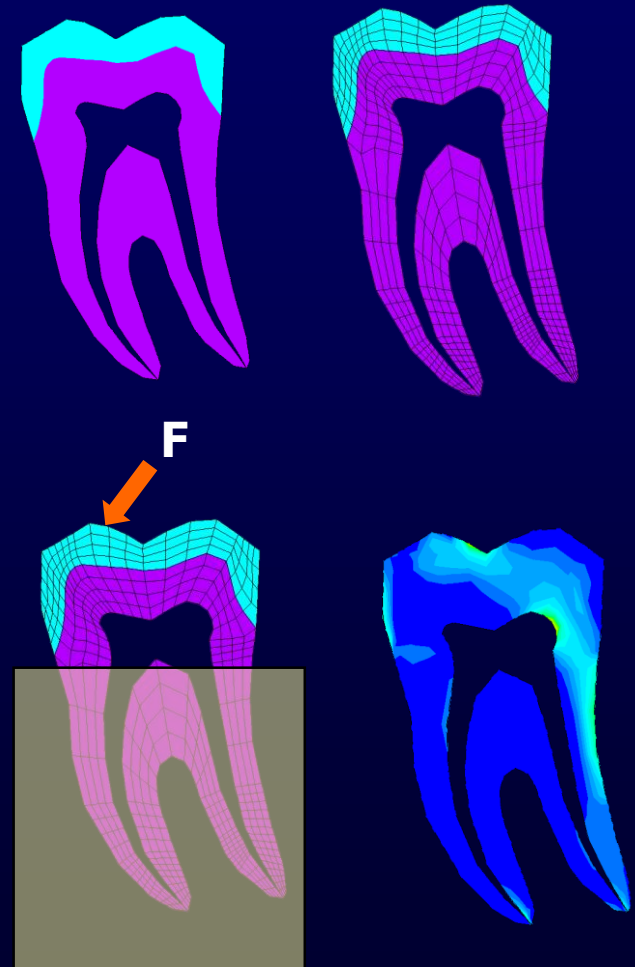

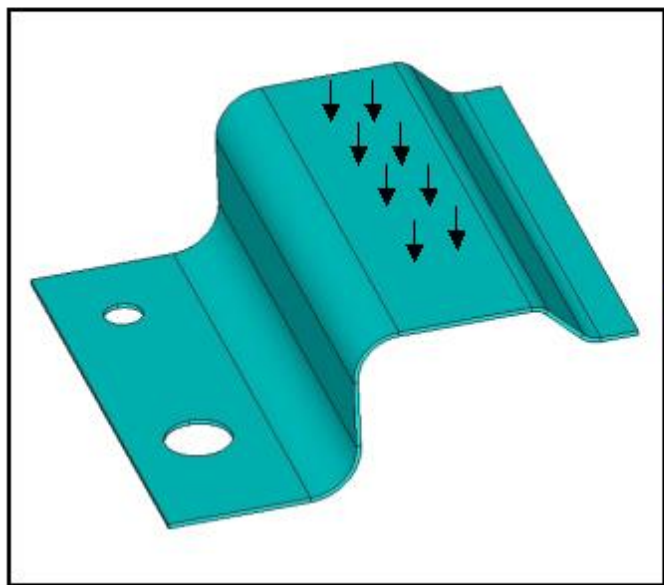

(a) 實際工程問題

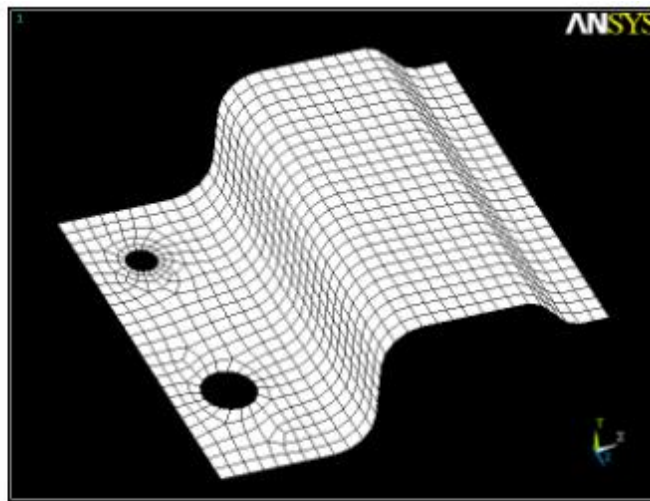

(b) 元素網格

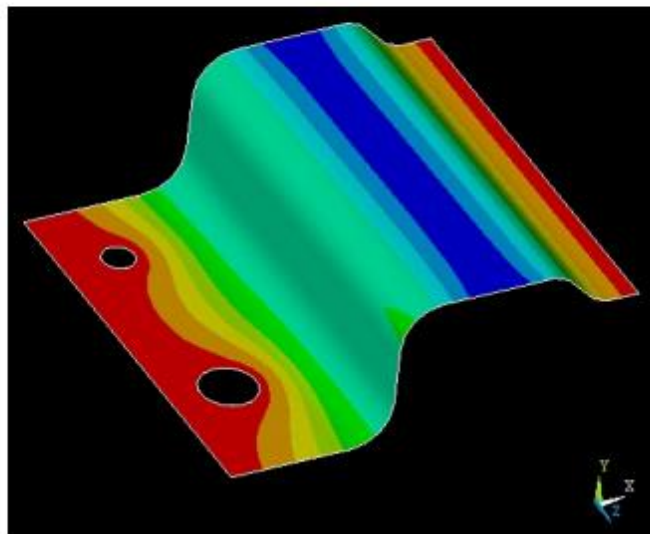

(c) 模擬之變形

# CAE general applications

## ❖ 電腦輔助工程 (Computer Aided Engineering, CAE)

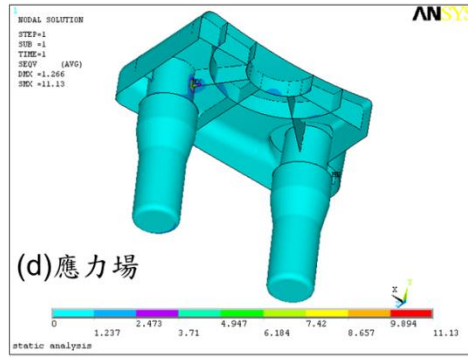
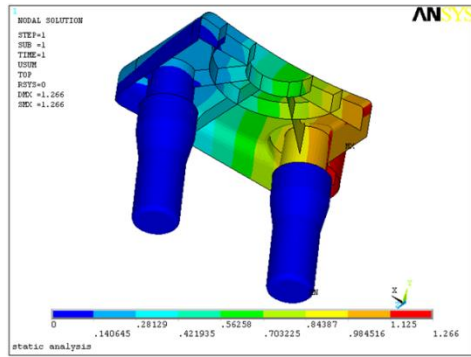
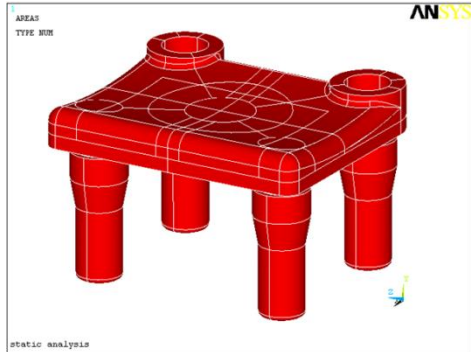

## 塑膠椅之力學分析

## 散熱風扇之模態分析

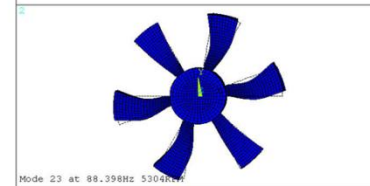
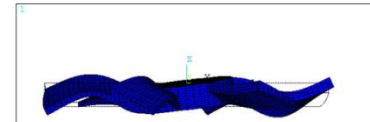
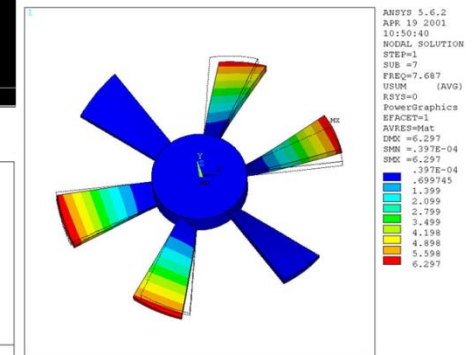
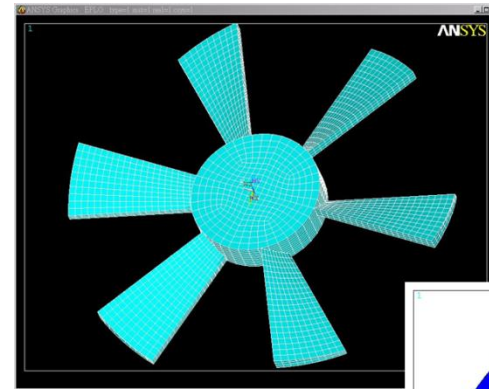

# Computer aided engineering (CAE)

- **Computer Aided Engineering**
  - CAE (Finite Element Method)
- **Finite Element Method (FEM)**
  - FEM is suitable theoretically for any structure
    - irregular geometry
    - inhomogeneity, anisotropy material properties
    - complex loading
  - Powerful analytical tool in biomechanics

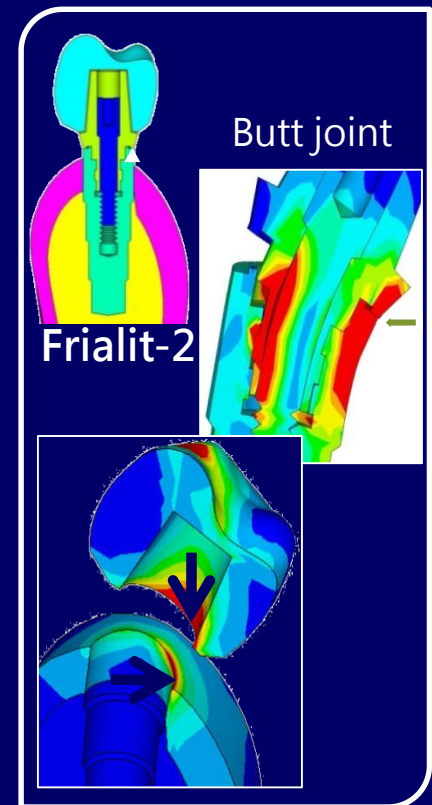
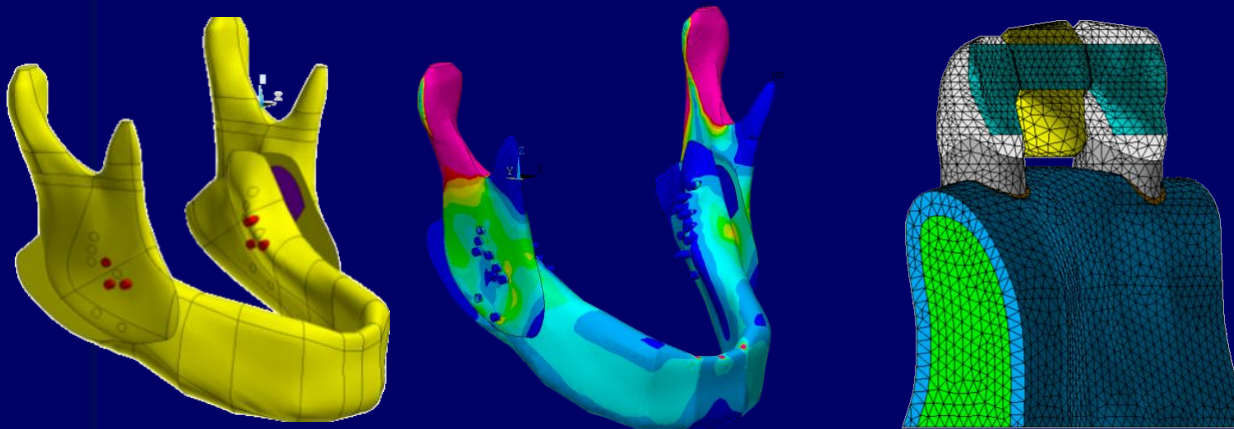

# 3D modeling for biological structure

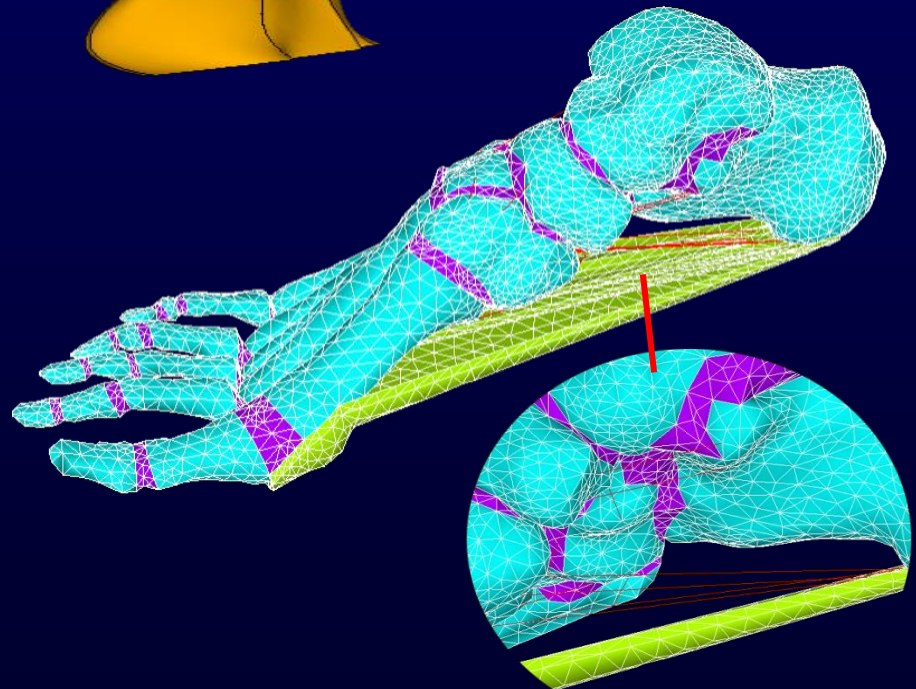
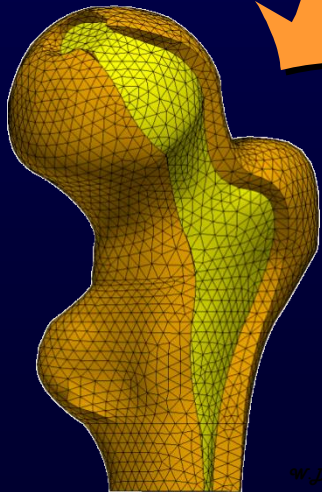
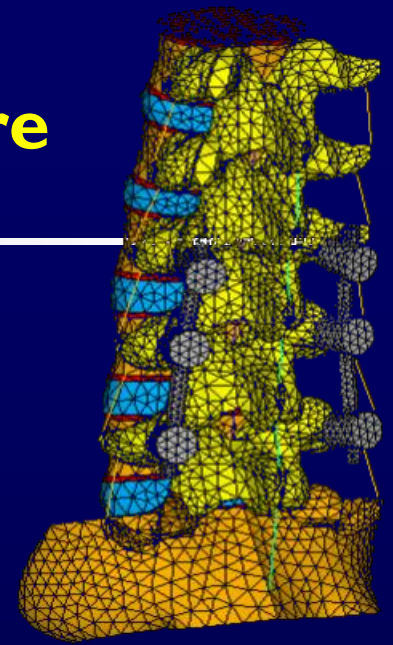
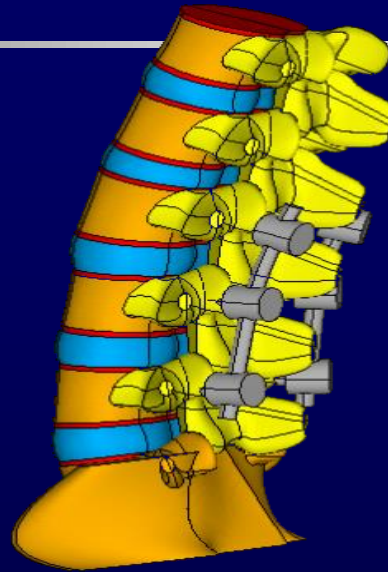
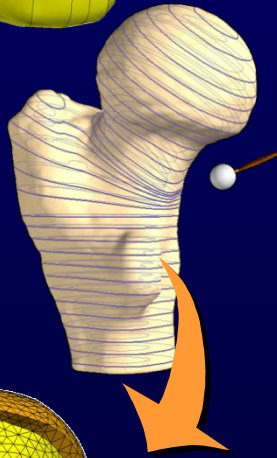
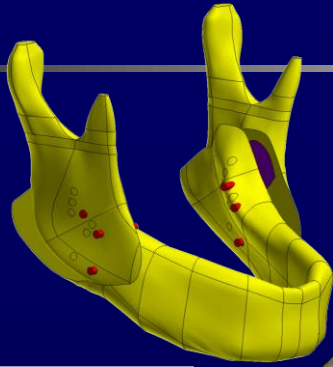

# 3C

## Forward Engineering

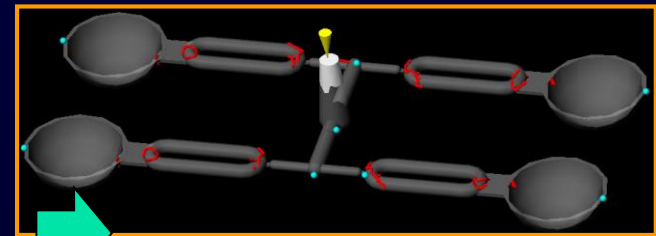
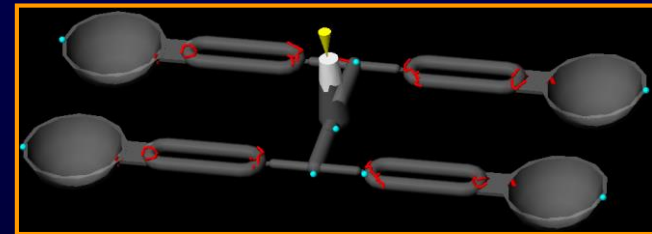
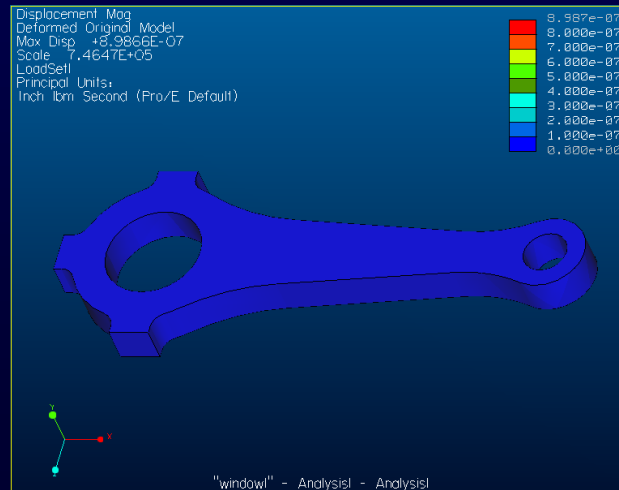
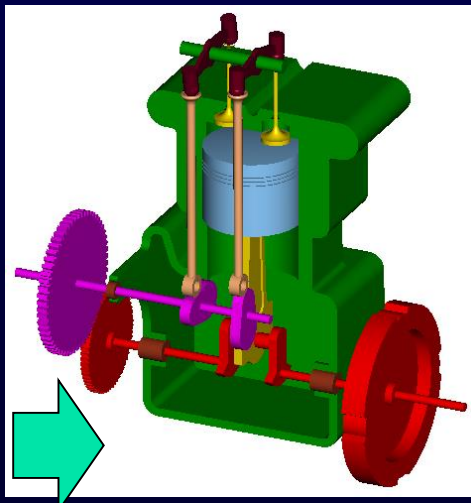
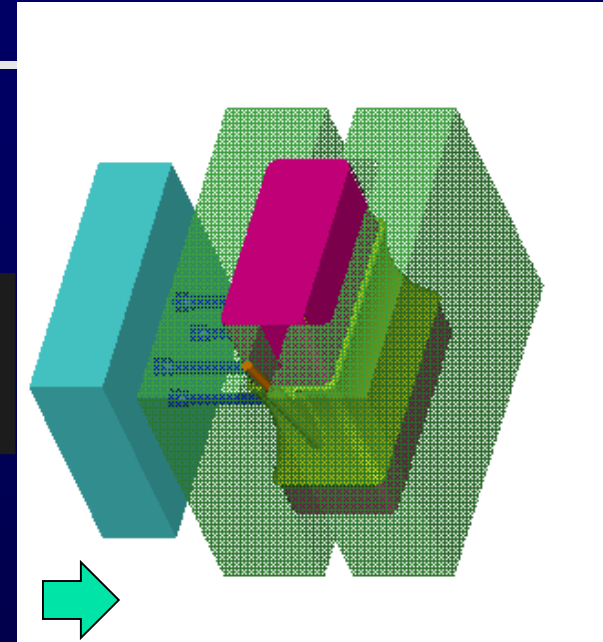

# CAE key factors

## ❖ 電腦輔助分析 (Computer Aided Engineering, CAE)

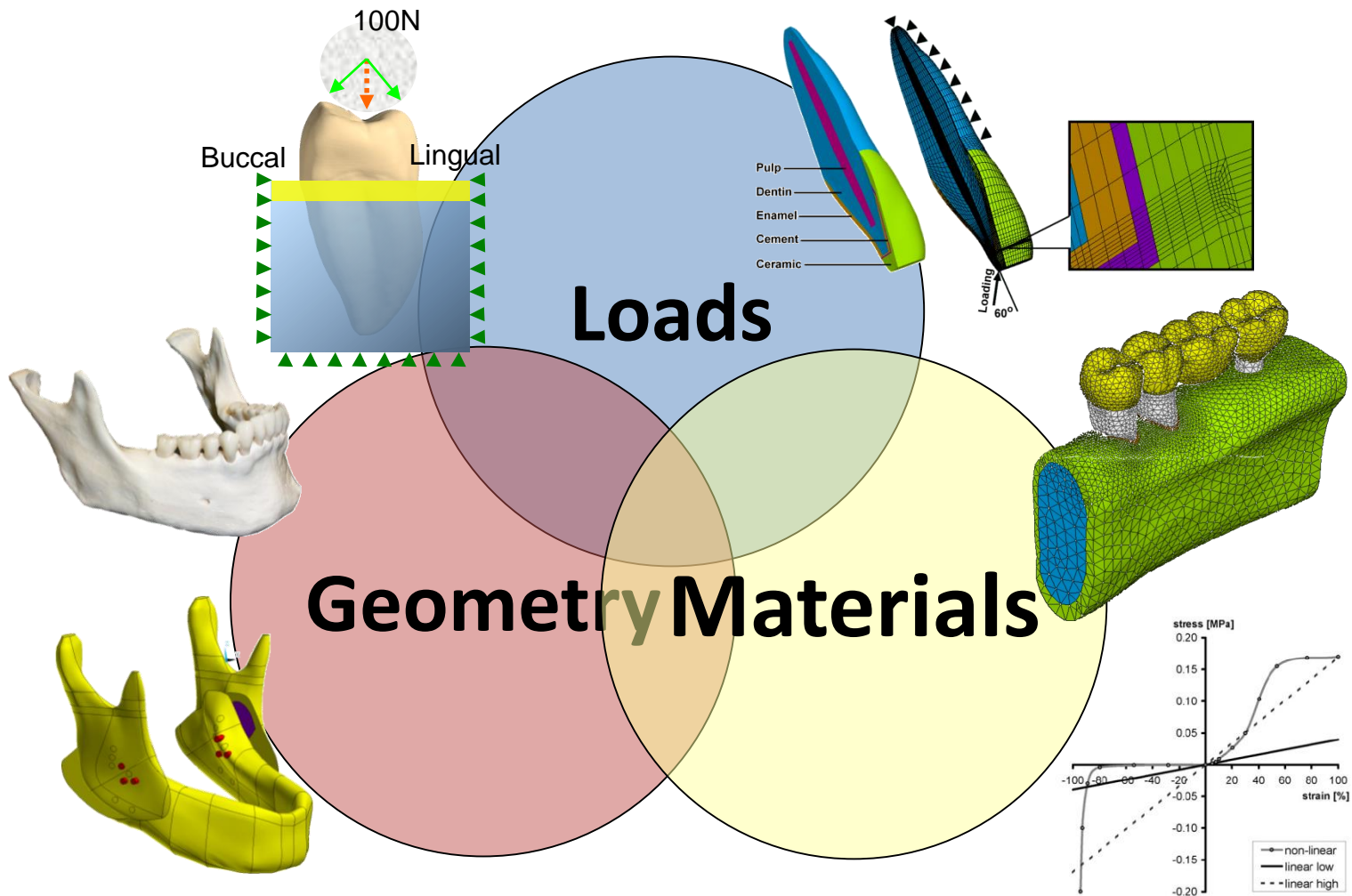

# 3D modeling for biological structure

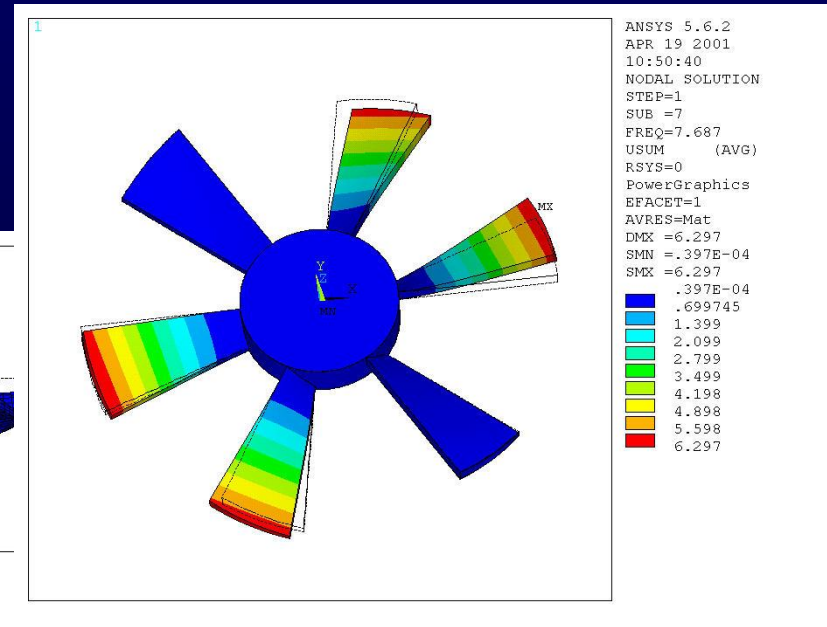
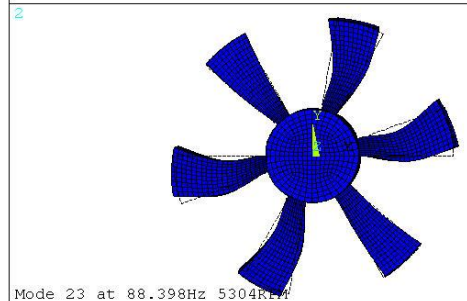
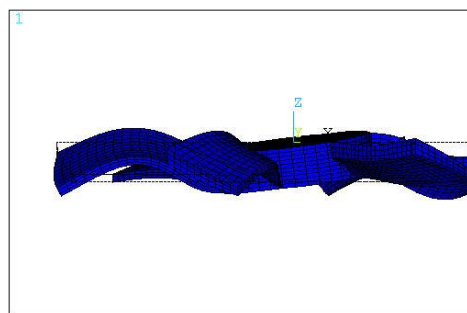
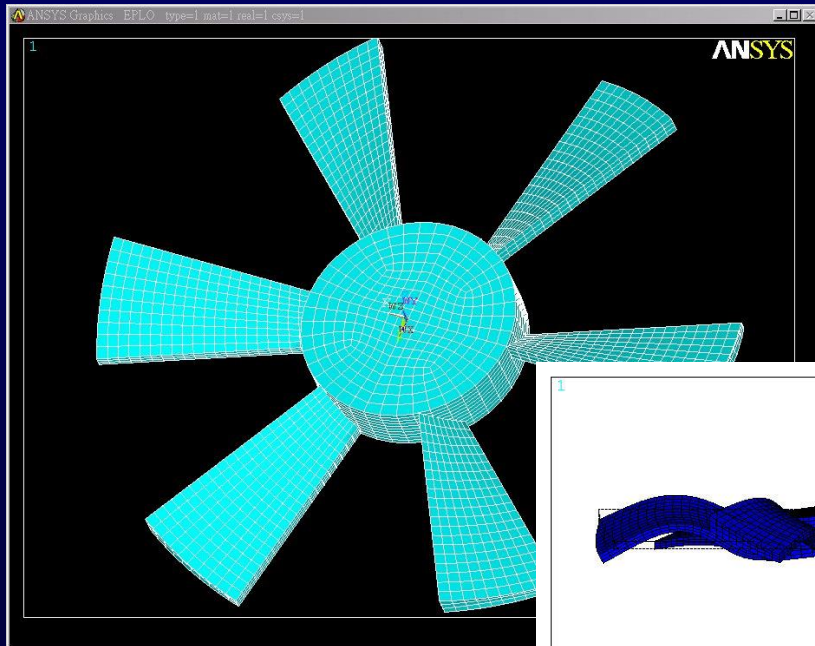

DSCA=.983199  
ZV =1  
DIST=65.522  
XF =.766196  
YF =-.613508  
ZF =-5.376  
Z-BUFFER

# 3D modeling for biological structure

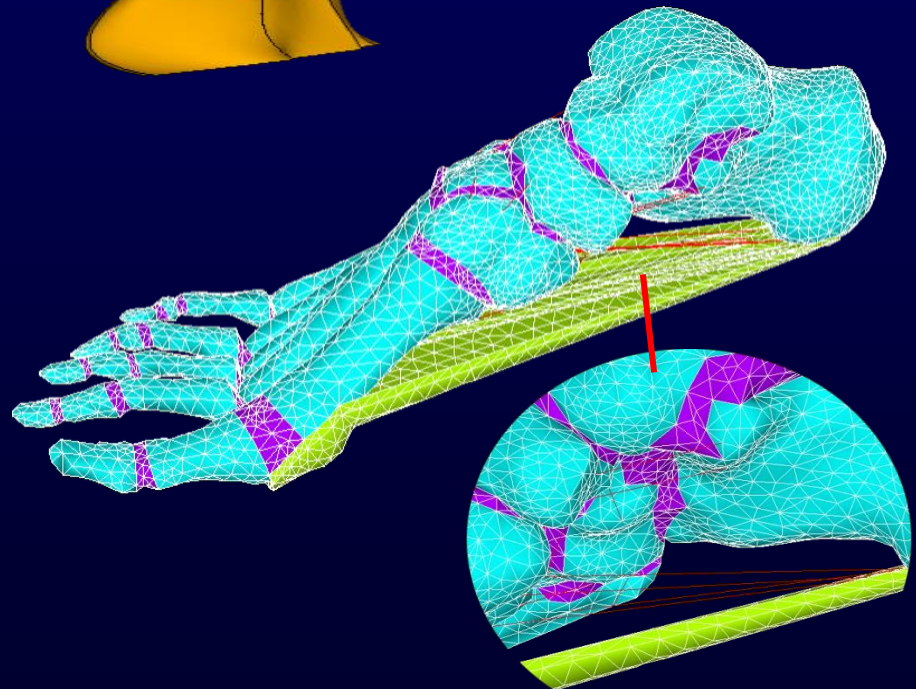
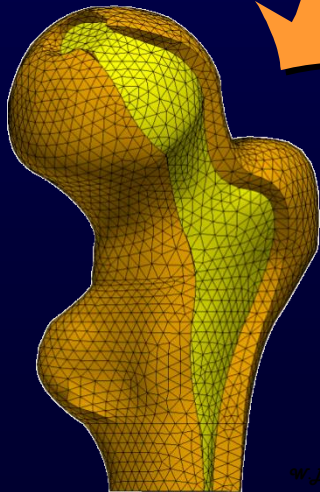
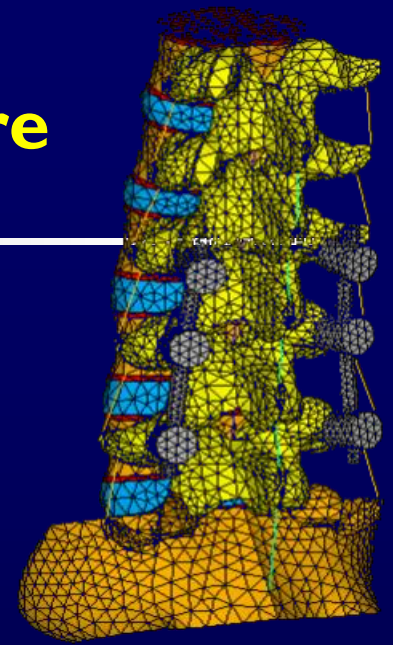
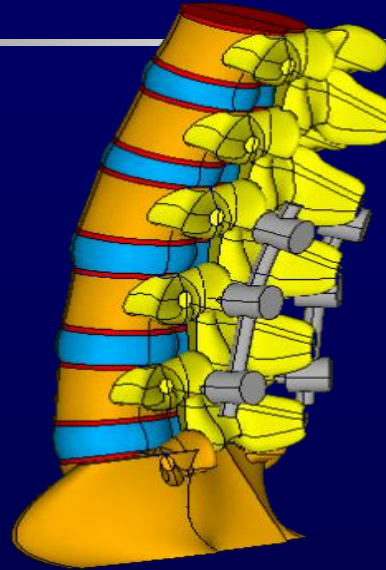
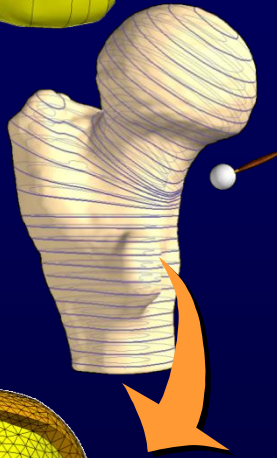
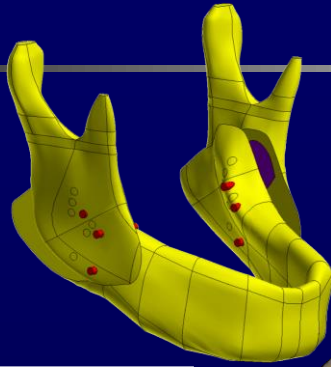

# 3D modeling for biological structure

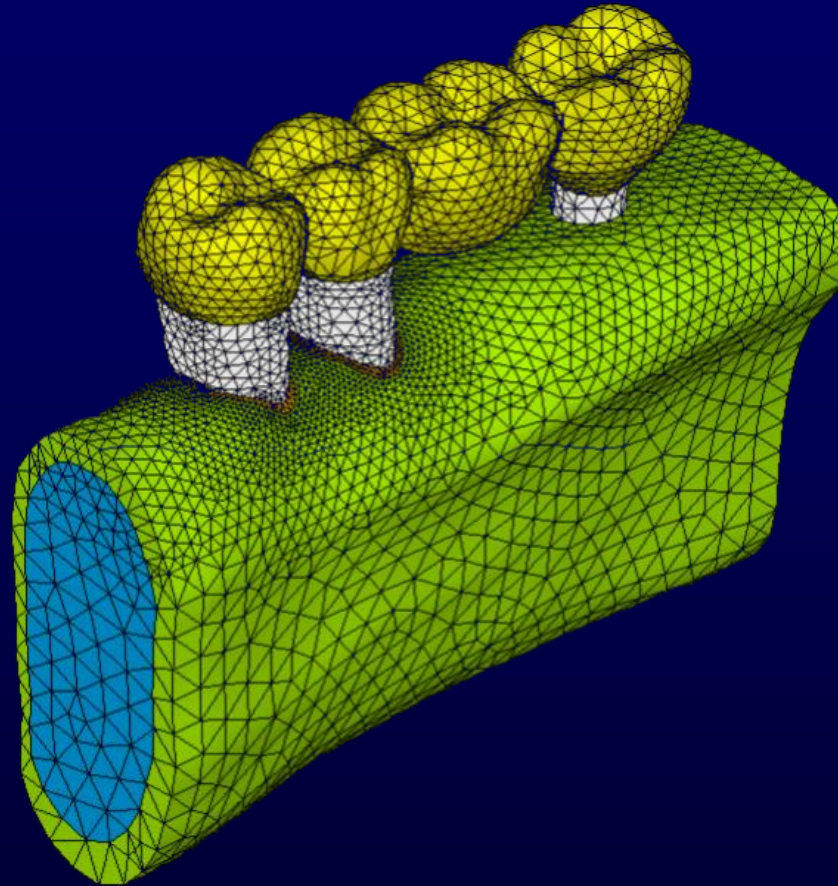

C.L. Lin, J.C. Wang\*, S.T. Chen, "Evaluation of stress induced of implant type and number of splinted teeth in different periodontal supported tooth-implant supported FPDs: a nonlinear finite element analysis", *Journal of Periodontology*, Vol. 81, pp.121-130, 2010.

# CAE key factors

## ❖ 電腦輔助分析 (Computer Aided Engineering, CAE)

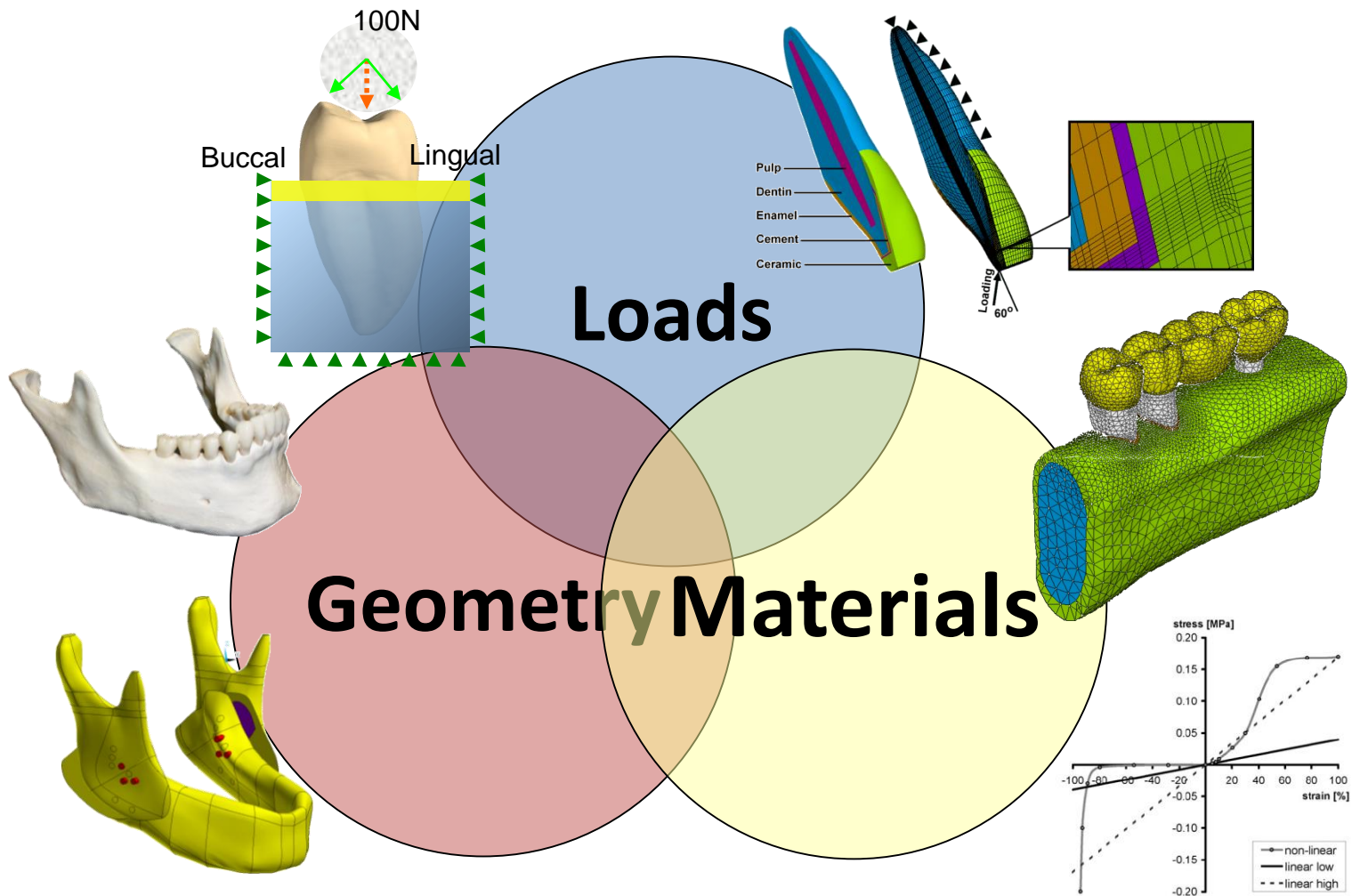

# Non linear analysis

## ■ Material property

- Non-homogeneous, anisotropic
- Viscous-elastic, Hyperelastic (PDL)

## ■ PDL

Authors	Elastic modulus (MPa)	Poisson's ratio
Vollmer	0.05/0.22	0.3
Andersen	0.07/0.8-68.9/13.8	0.49/0.3-0.45/0.49
Yettram	0.18	0.49
Tanne	0.67	0.49
Williams	1.5/100	0-0.45
Korioth	2.5-3.2	0.45
Farah	6.9	0.45
Takahashi	9.8	0.45
Ree	50	0.49
Cook	68.9	0.49
Ko	68.9	0.45
Atmaram	171.6	0.45
Thresher	1379	0.45
Goel	1750	0.49

# CAE-material

❖ 電腦輔助分析 (Computer Aided Engineering, CAE)

## Materials

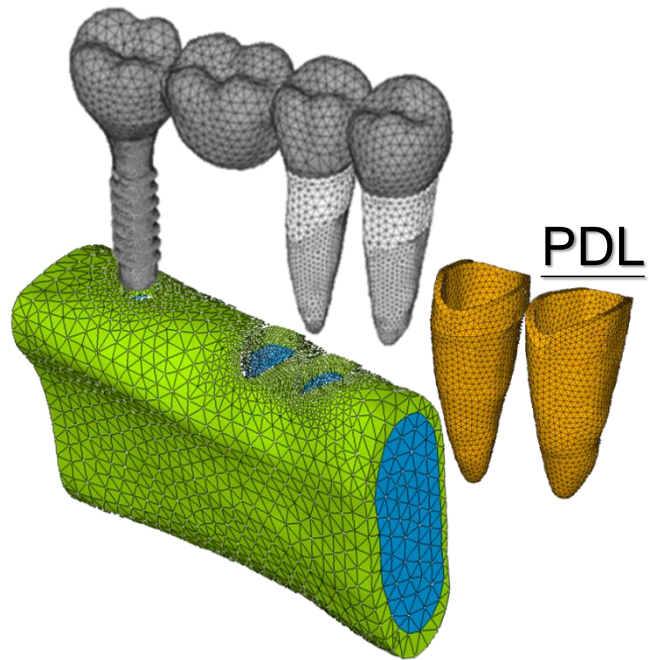

### Nonlinear material property

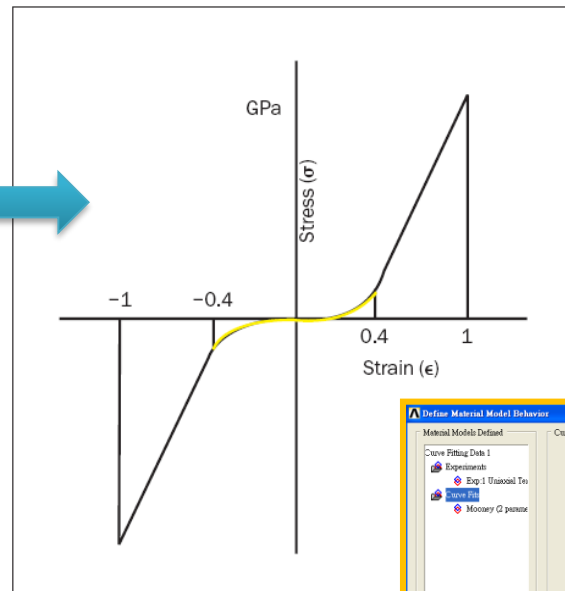

$$\sigma = 1.498246 \times 10^{-2} \epsilon^3$$

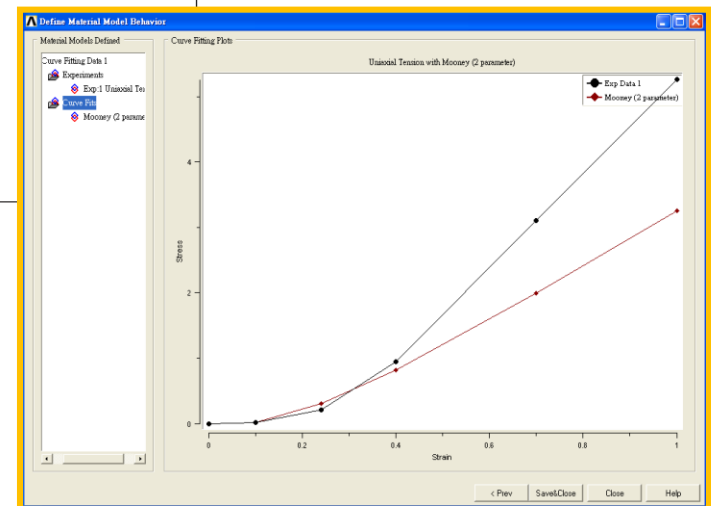

Material property simulation

# CAE-material

## ❖ 電腦輔助分析 (Computer Aided Engineering, CAE)

### Materials

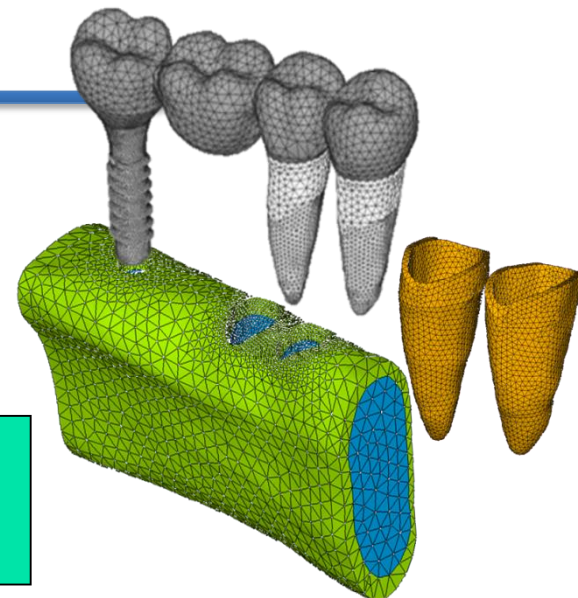

Hyper Max Dis = -10.31  
Normal Max Dis = -1.23

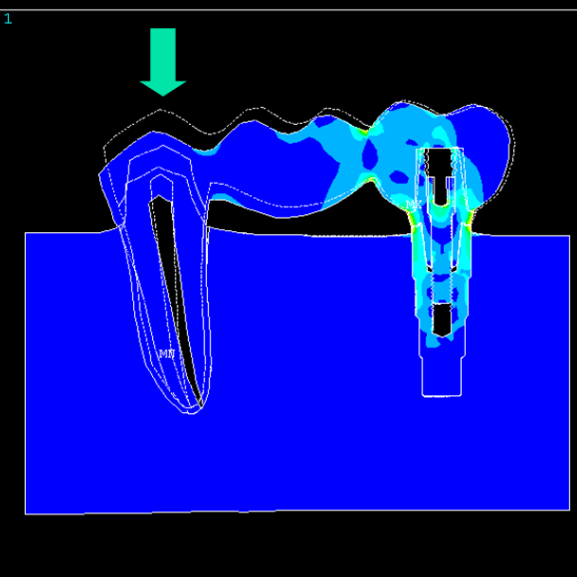

```
ANSYS 11.0  
APR 6 2009  
13:38:28  
NODAL SOLUTION  
STEP=1  
SUB =24  
TIME=1  
SEQV (AVG)  
PowerGraphics  
EPACET=1  
AVRES=Mat  
DMX =.01054  
SMN =.272E-04  
SMX =10.744  
.272E-04  
1.194  
2.388  
3.581  
4.775  
5.969  
7.163  
8.357  
9.55  
10.744
```

Displacement 及 stress  
均有極大差異

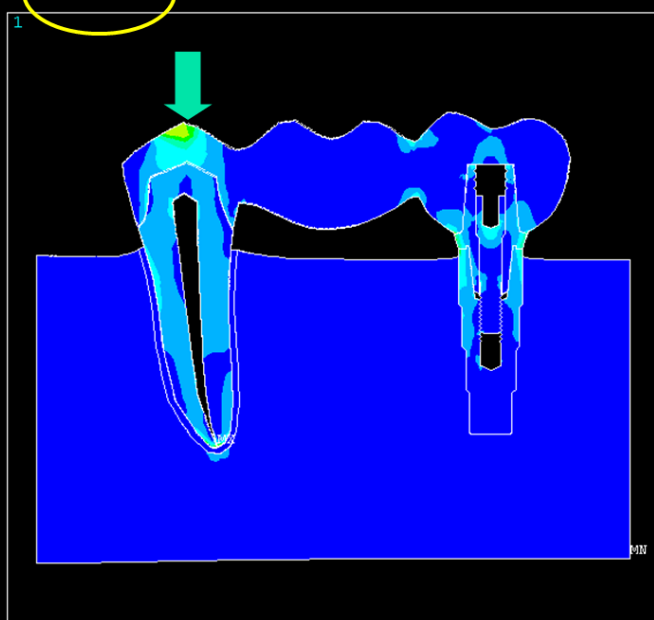

```
ANSYS 11.0  
APR 6 2009  
13:42:57  
NODAL SOLUTION  
STEP=1  
SUB =1  
TIME=1  
SEQV (AVG)  
PowerGraphics  
EPACET=1  
AVRES=Mat  
DMX =.621E-03  
SMN =.001249  
SMX =1.125  
.001249  
.126165  
.251081  
.375997  
.500913  
.625829  
.750745  
.875661  
1.001  
1.125
```

***Easy to do, hard to do well!***

***Validation with experiments***

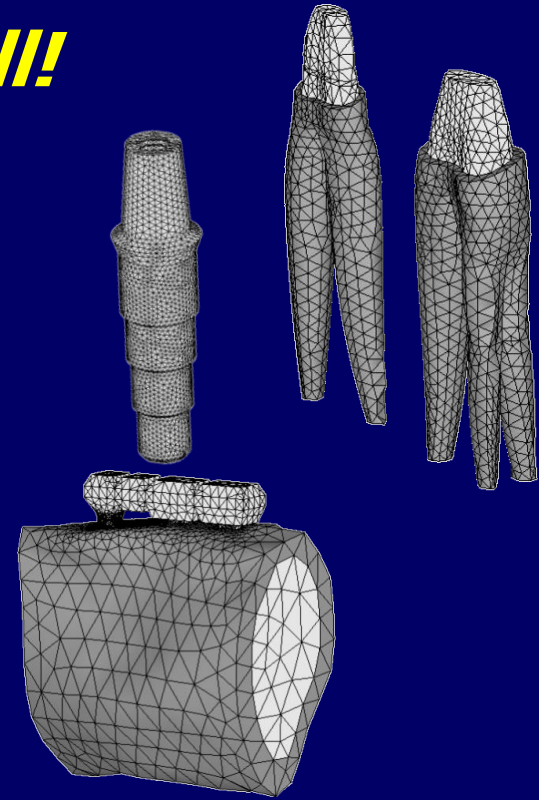

# 自然牙齒構造

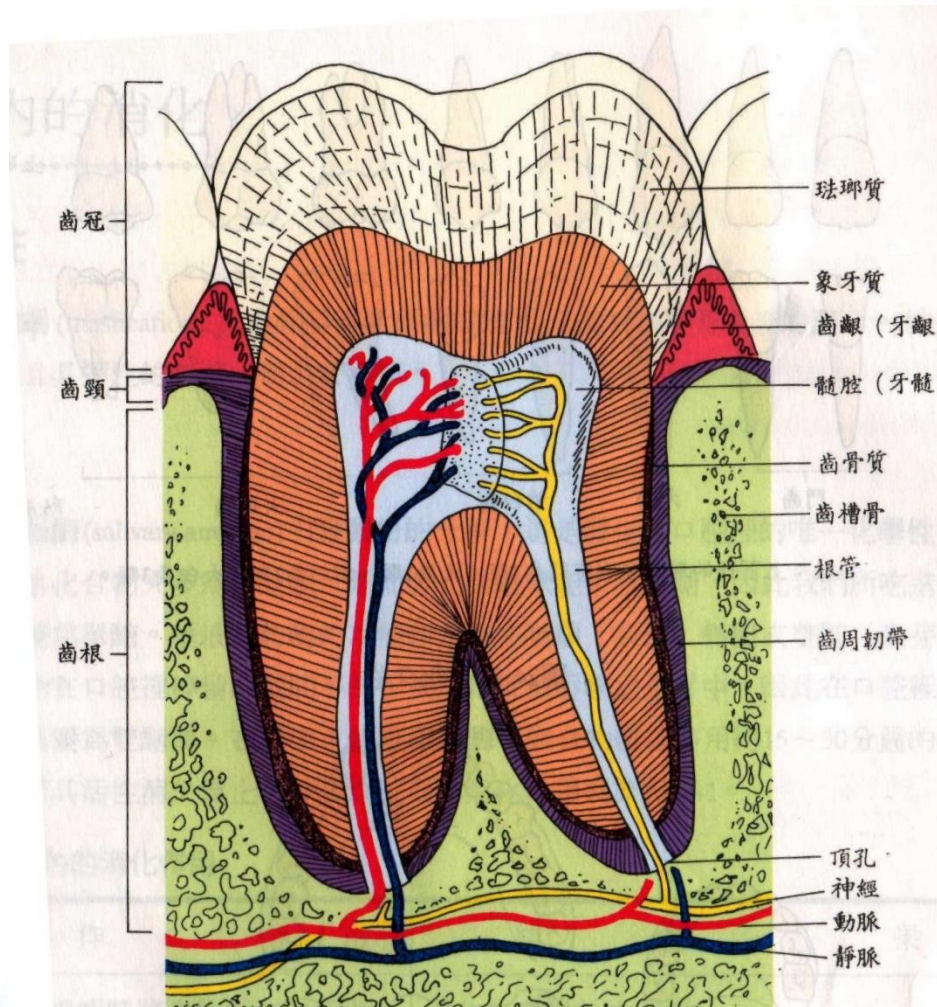

## 自然牙齒

- 第一套乳牙- 20顆
- 第二套恆牙- 32顆

## 齒槽骨

- 由膠質、礦物質、纖維蛋白和基質所組成。
- 牙齒脫落會發生骨吸收現象

# 何謂人工牙根？

- 以純鈦金屬或鈦合金人工牙根種植到缺牙區的齒槽骨
- 人工牙根與骨細胞產生緊密的結合(骨整合)
- 在人工牙根表面必須經過特殊的處理



# Tooth Replacement with Dental Implants

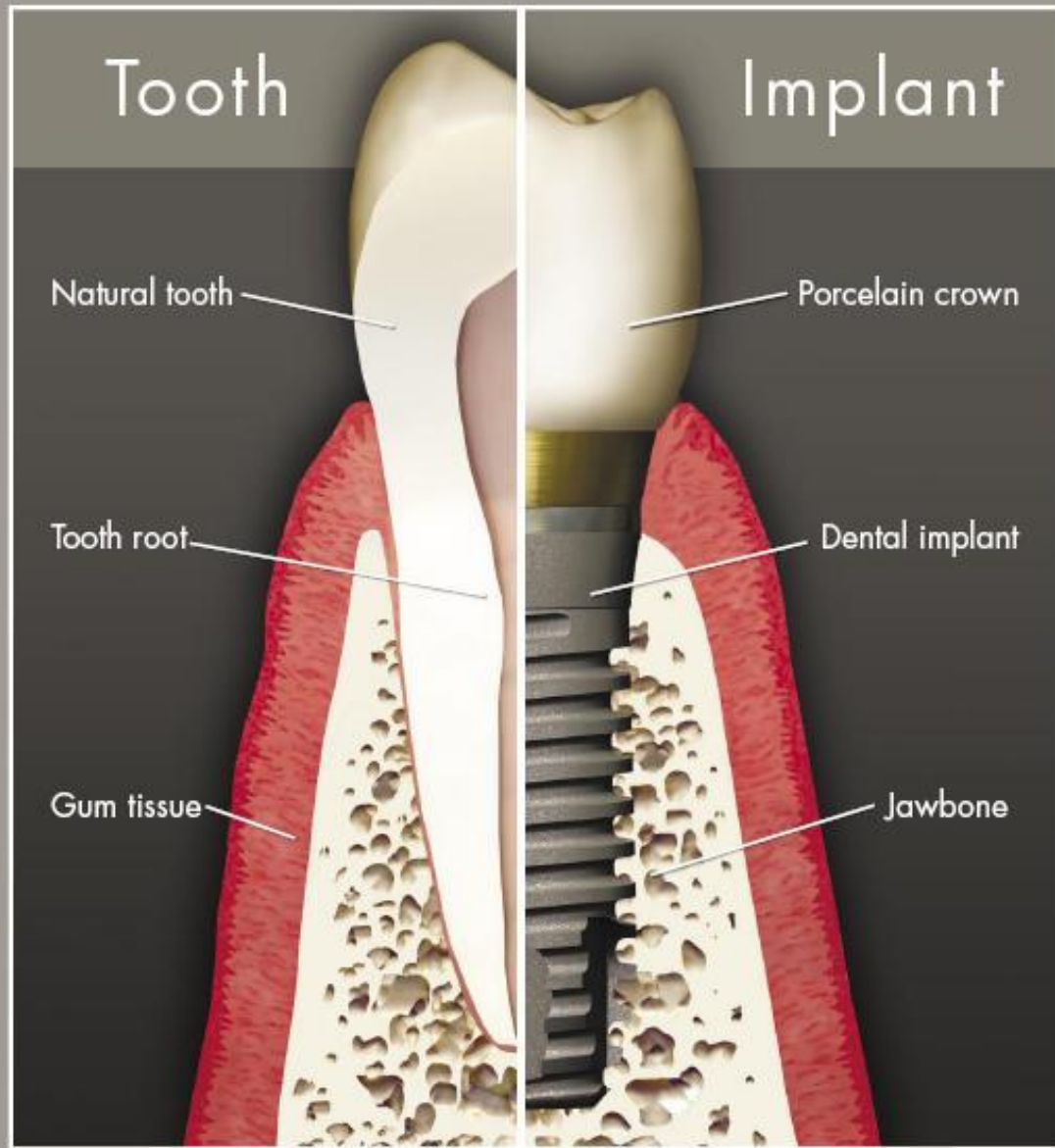

# 人工牙根簡要

## ● 人工牙根

### ● 定義

- 以人工替代物種植到缺牙區的齒槽骨以取代原本牙齒的功能

### ● 目的

- 恢復口腔中牙齒咀嚼之功能

### ● 骨整合機制

- 必須經過3至6個月人工牙根的表面與骨細胞產生緊密的結合

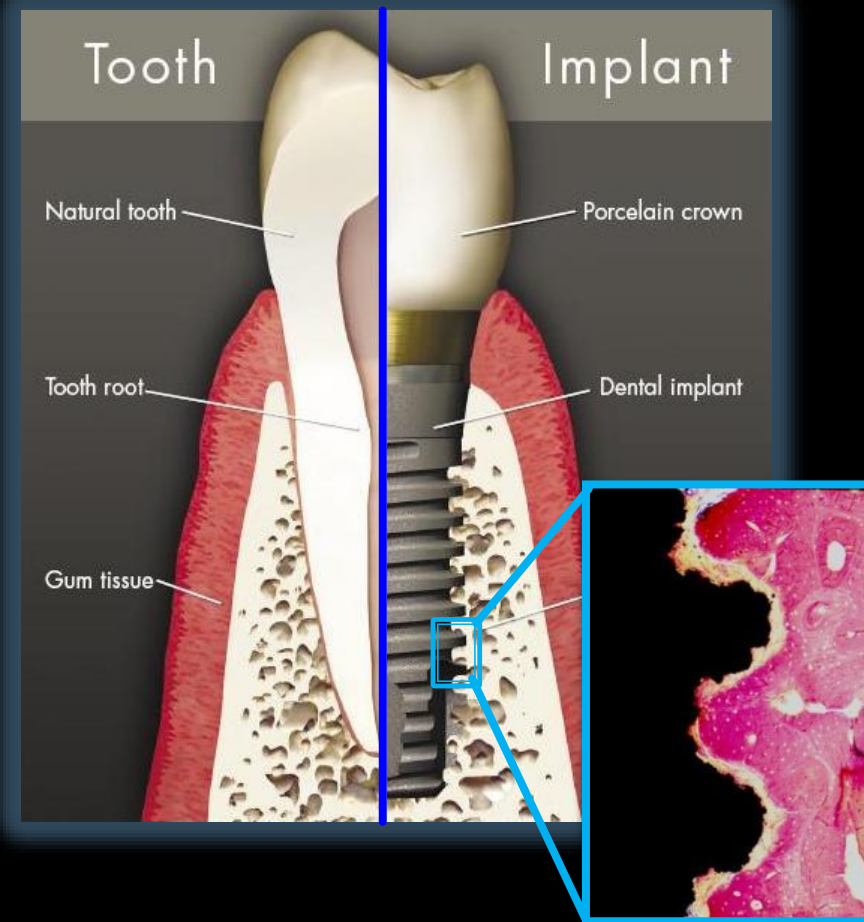

# 人工牙根成功條件

## ● 人工牙根成功條件

- 初期：良好的骨整合效果
- 長期：避免骨整合流失

## ● 影響骨頭受力之因素

### ● 生物力學因素

- 人工牙根及支台外形設計
- 人工牙根植入形式
- 咬合力形式

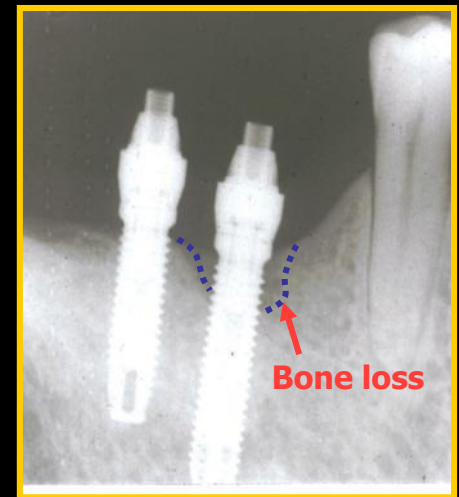
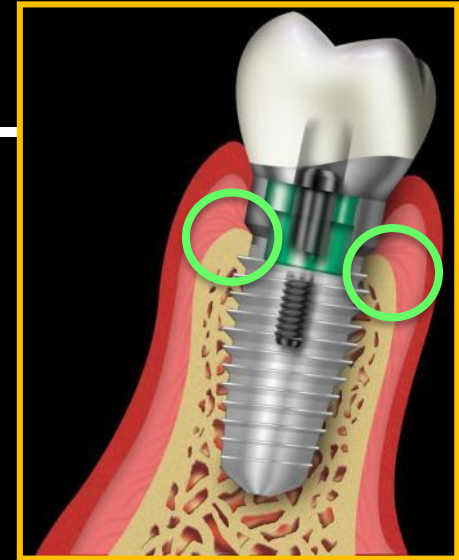

# Dental Implant

## Surgical classification

## Feature classification

### 1 stage

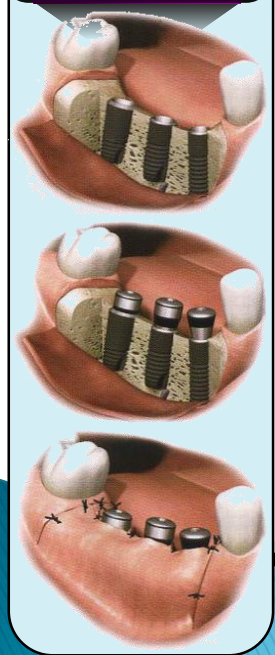

### 2 stage

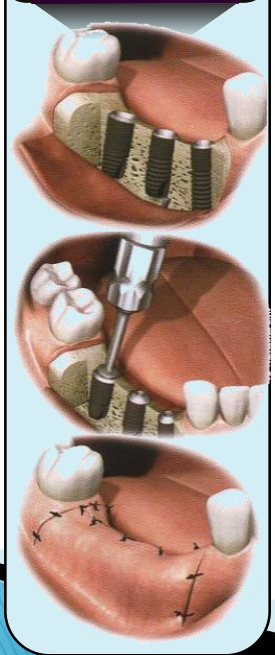

### Immediate placement

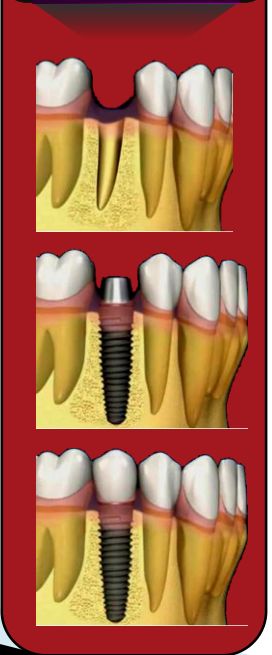

### 1 piece



### 2 piece



### 3 piece

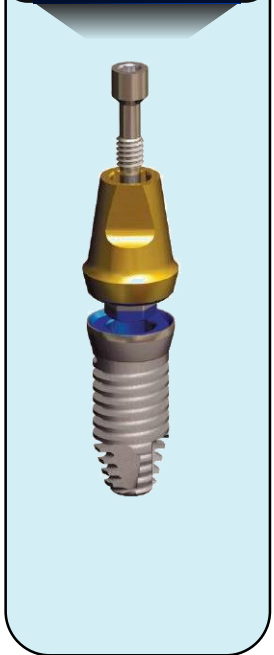

# Success rate & factors

Immediate placement 80%  
Traditional placement 95%

## Initial stability

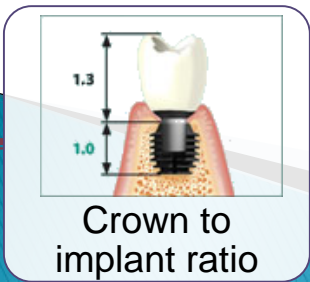
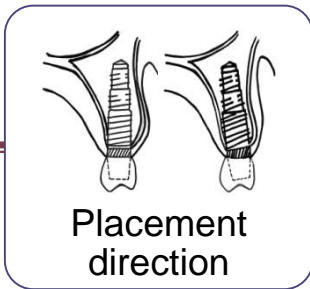
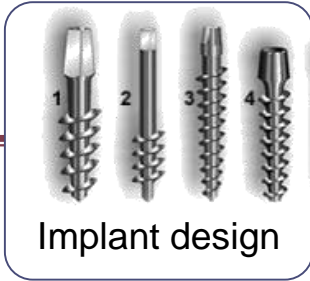

## Bone situation

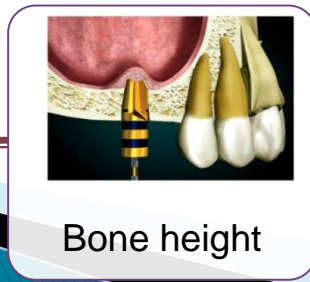
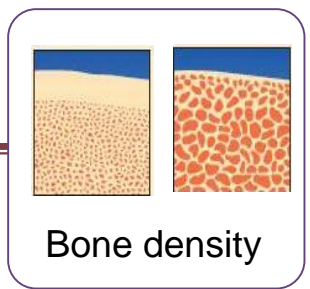
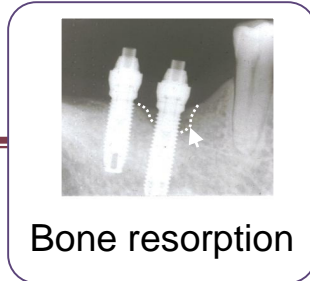

## Clinical factor

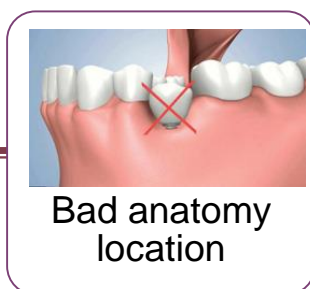

## Patient habits

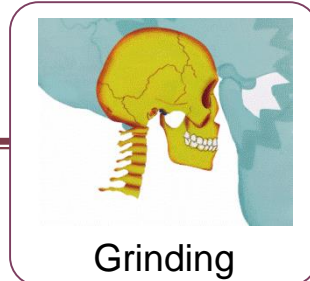

# Biomechanical factors

## Initial stability

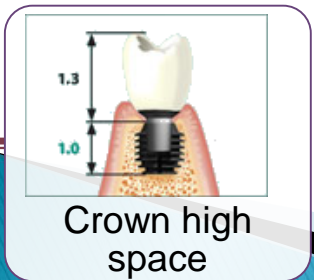
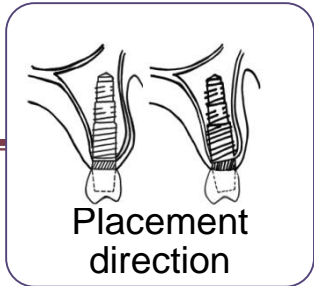
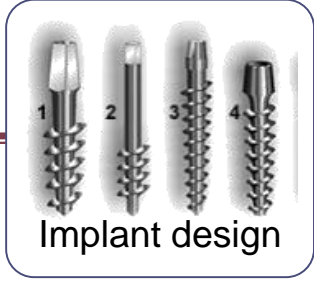

## Bone situation

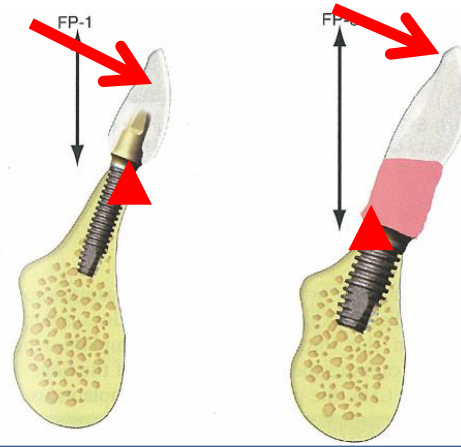
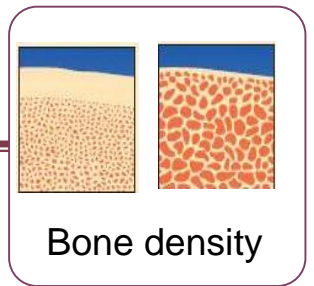
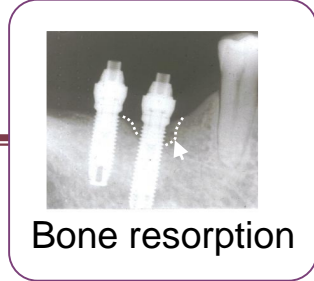

CHS 會產生“槓桿”現象  
越高的CHS會產生越大的應力

CHS: Crown Height Space 冠高空間

## 生物力學&生理機械

Biomechanics & Mechano biology

- 人工牙根設計
- 骨質流失
- 骨質密度



## 病患生理&醫師考量

- 植體植入位置
- CHS
- 牙周狀態 / 骨質密度

# 生物力學&生理機械-人工牙根設計綱要

巨觀考量

連結器 (Connection)

頸部設計 (Crest design)

主體螺牙 (Body thread)

植體外型 (Implant shape)

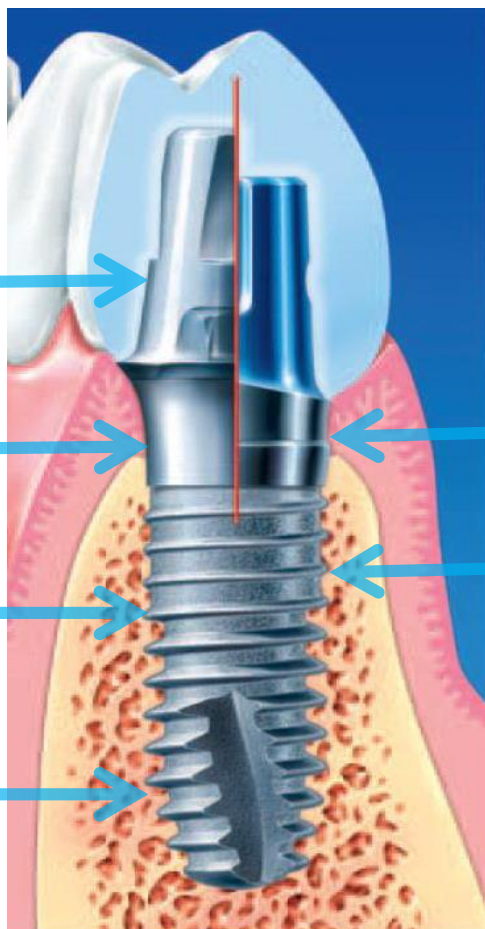

微觀考量

近端螺紋 (Proximal thread)

表面處理 (Surface treatment)

# 人工牙根設計 (1/2)

	Nobel Biocare	Straumann (ITI)	Innovations (3i)	Densply (Frialit-2)	Astra Tech (Astra)
植體圖					
植體外型	斜錐狀	圓柱狀	斜錐狀	階梯狀	斜錐狀
主體螺牙	深螺紋 自攻設計	淺螺紋	深螺紋 自攻設計	無	深螺紋 自攻設計
頸部設計	無	無	Platform switching	無	Platform switching

# 人工牙根設計 (2/2)

	Nobel Biocare	Straumann (ITI)	Innovations (3i)	Densply (Frialit-2)	Astra Tech (Astra)
植體圖					
連結器設計	三瓣式 搭配螺絲	Morse taper	內六角 搭配螺絲	內六角 搭配螺絲	內十二角 搭配螺絲
近端細螺紋	有	無	無	無	有

# 醫學影像掃描及處理

## ● 醫學影像掃描

### ● 上/下顎骨

- 健康40歲男性
- 小白齒區無牙狀態
- CT掃描間隔：1mm

### ● 人工牙根

#### ● 廠牌：

- Nobel Biocare (Replace)
- Straumann (ITI)
- Biomet (3i)
- Densply (Frialit-2, XiVE)
- Astra Tech (Astra)

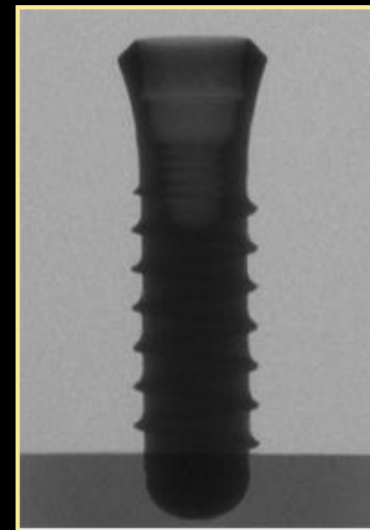
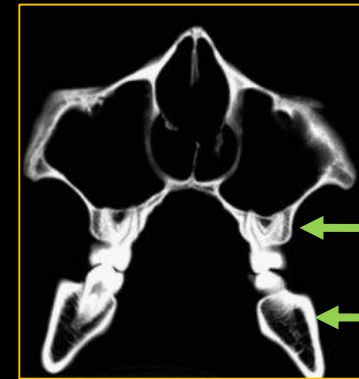

# 醫學影像掃描及處理

## ● 上顎骨醫學影像掃描及處理

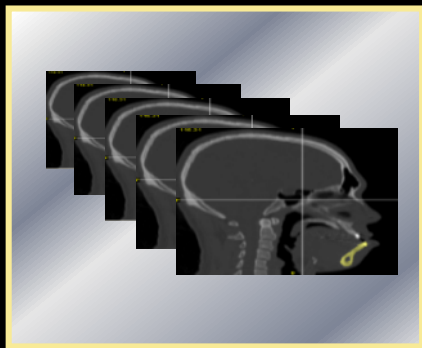

醫學影像處理

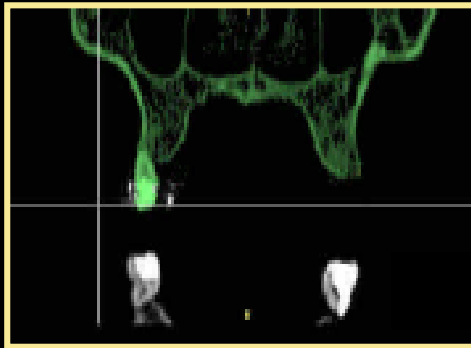

閾值調整及部位選取

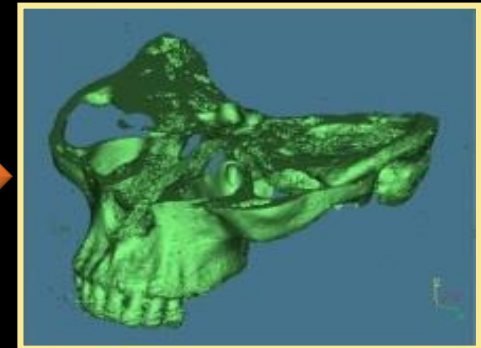

影像重組

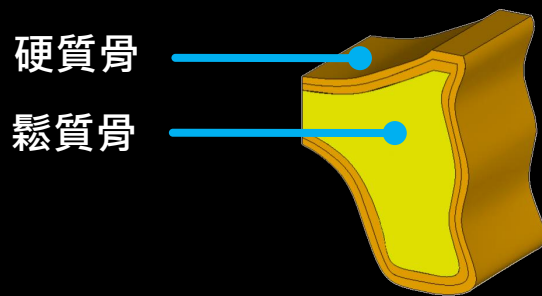

上顎第二小白齒區  
顎骨外型建構

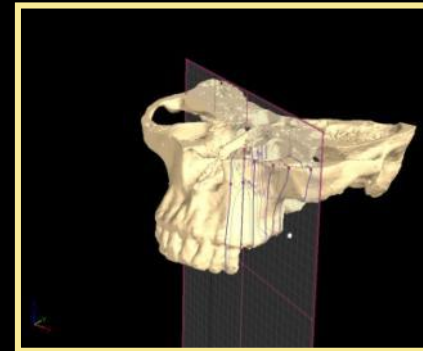

輪廓外形擷取

# 電腦輔助工程設計(CAD)

## 五大廠牌植體模型建構

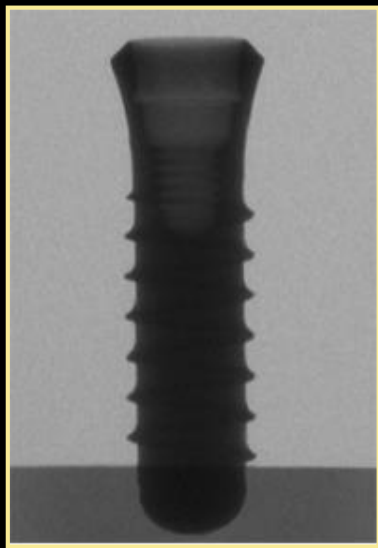

醫學影像處理

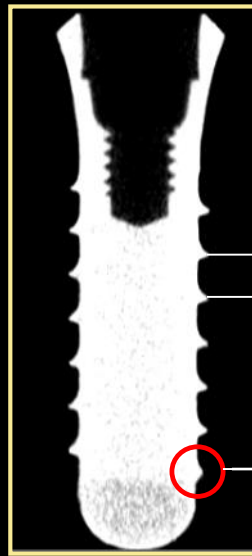

各部位尺寸量測

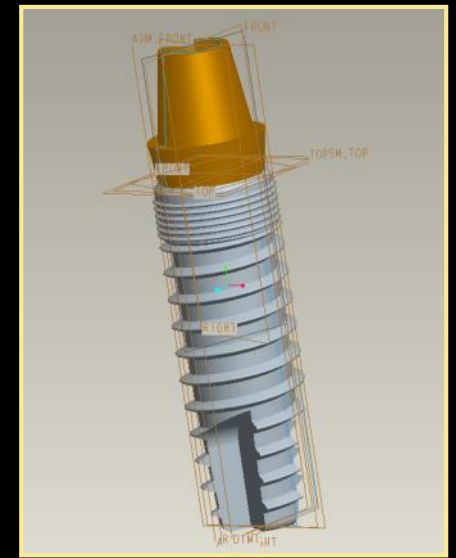
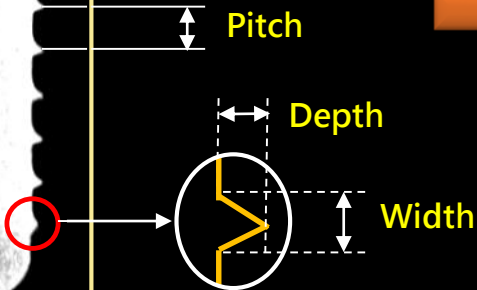

電腦輔助設計 (CAD)

# 設計 (三瓣搭配螺絲)

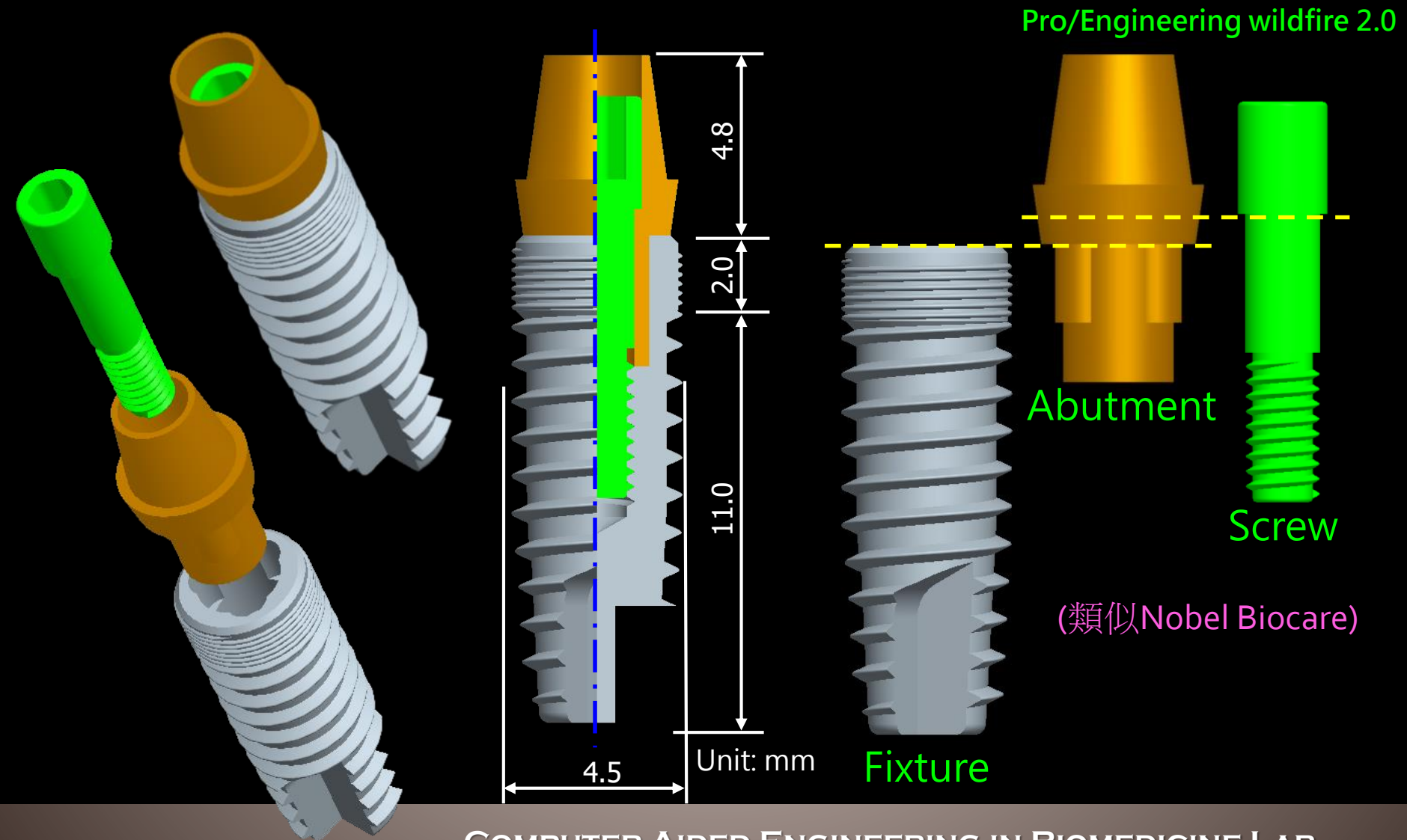

# 電腦輔助工程設計(CAD)

## ●人工植體模型

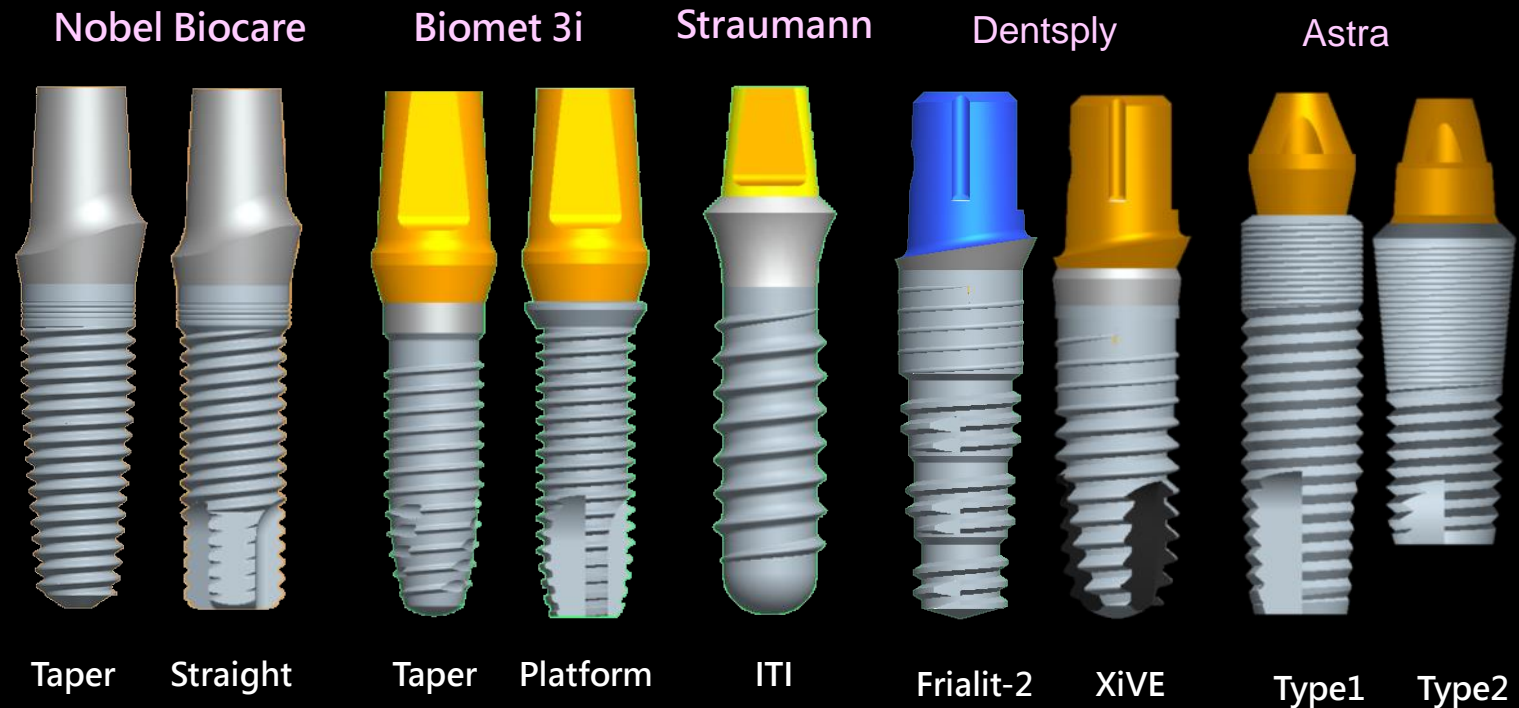

# 有限元素模型建構

- 上顎骨與人工牙根模型組合
- 各部位模型位置確立及布林運算

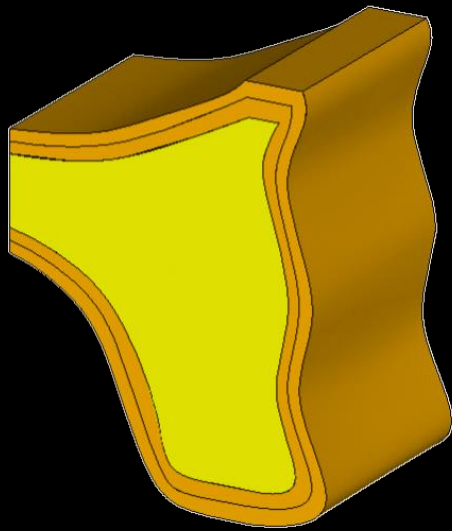

上顎骨模型



人工植體模型

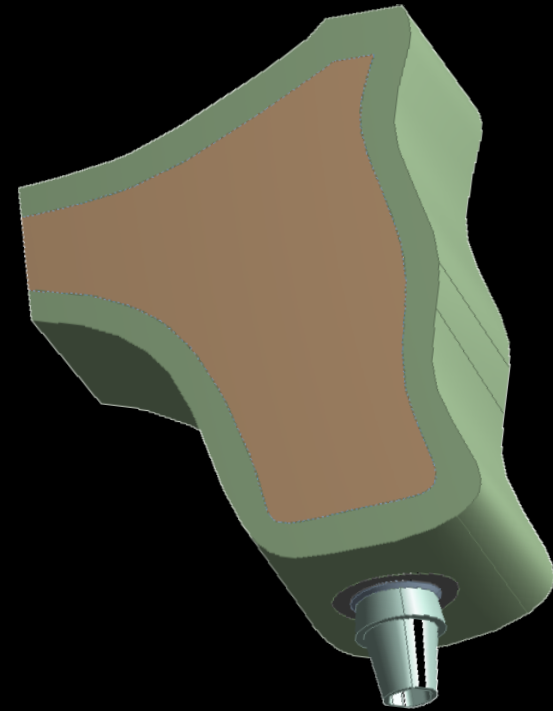

顎骨/人工植體模型

# 有限元素非線性模擬分析

## ● 模型網格化

- 使用三維四面體十節點元素(Solid 92)進行自由化網格

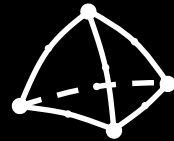

## ● 材料特性給定

- 硬質骨、鬆質骨及植體皆為等向均質材料

	彈性係數 (MPa)	樸松比
■ 硬質骨	14700	0.3
■ 鬆質骨	1470	0.3
■ 鈦合金	110000	0.35

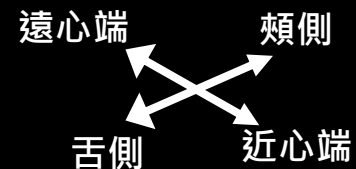
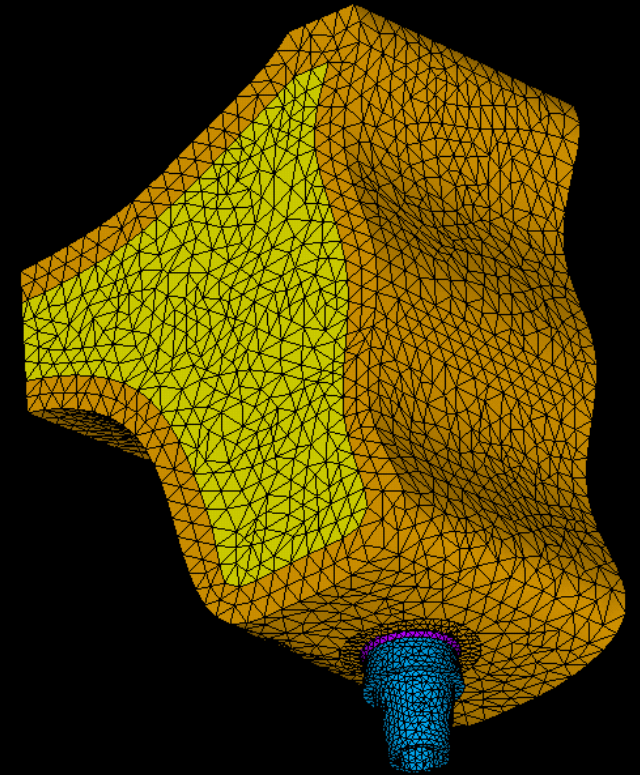

# 有限元素非線性模擬分析

- 邊界條件給定

- 近遠心端處節點自由度為零

- 負載條件給定

- 軸向負載：100N
- 側向負載：100N

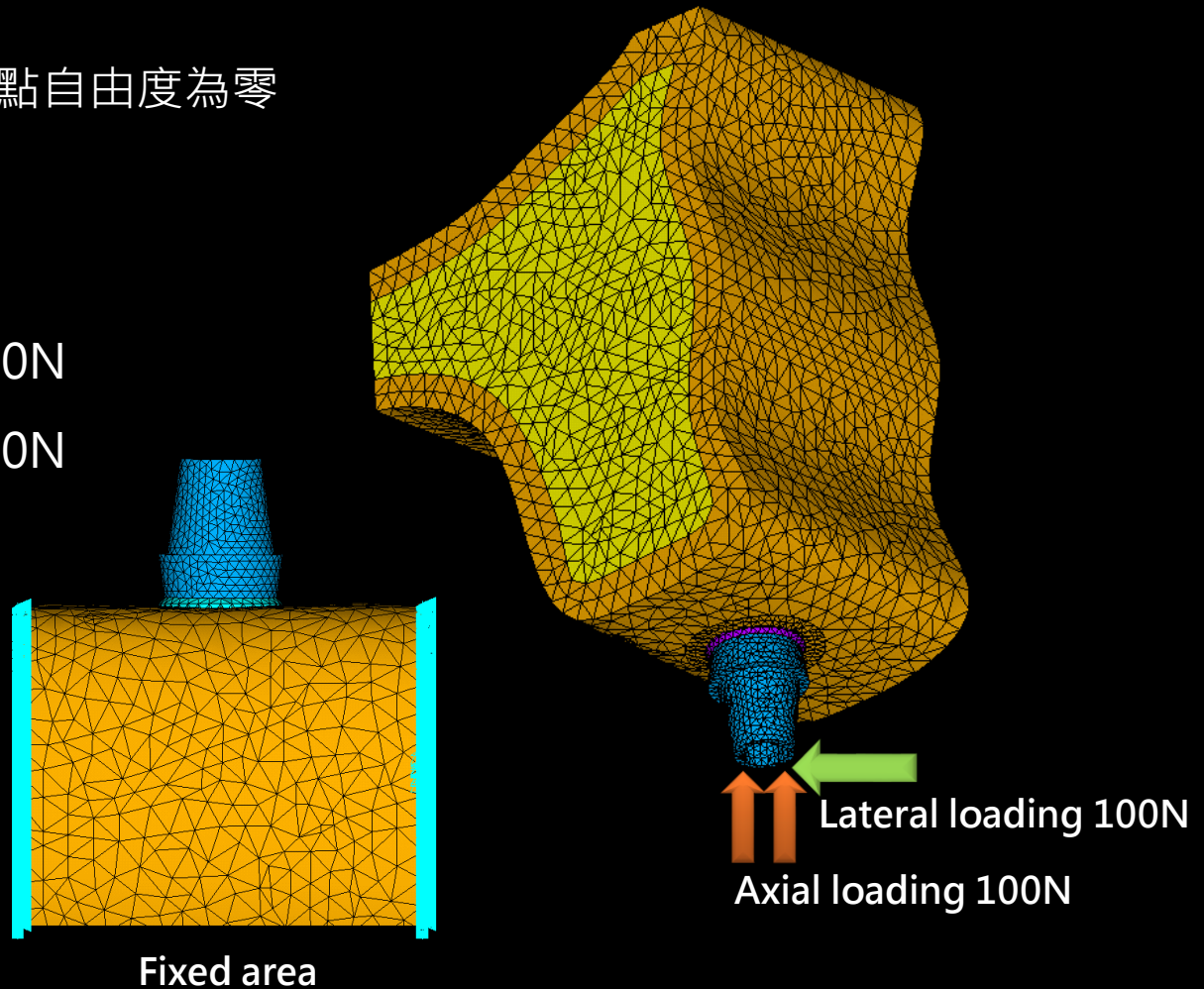

# 模擬分析觀察數值

## ● 人工牙根成功條件

- 避免骨整合流失
- 避免植體元件斷裂



## ● 觀察結果

### ● 骨頭應變值

- 骨頭應變值(ustrain)超過4000時

Frost. et. 2004

### ● 人工植體應力值

- 鈦金屬之破壞強度為 1000 MPa

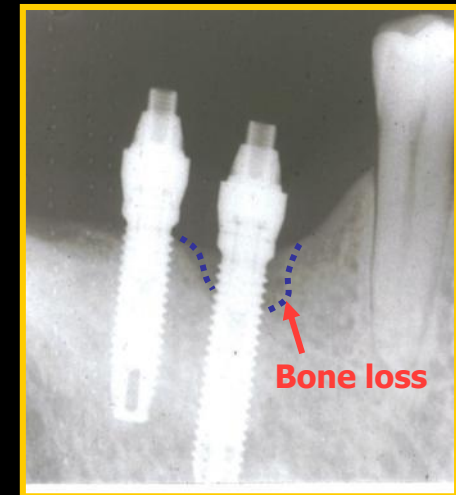

# 有限元素模擬分析結果(上顎)

## ● 植體應力分佈圖-側向負載

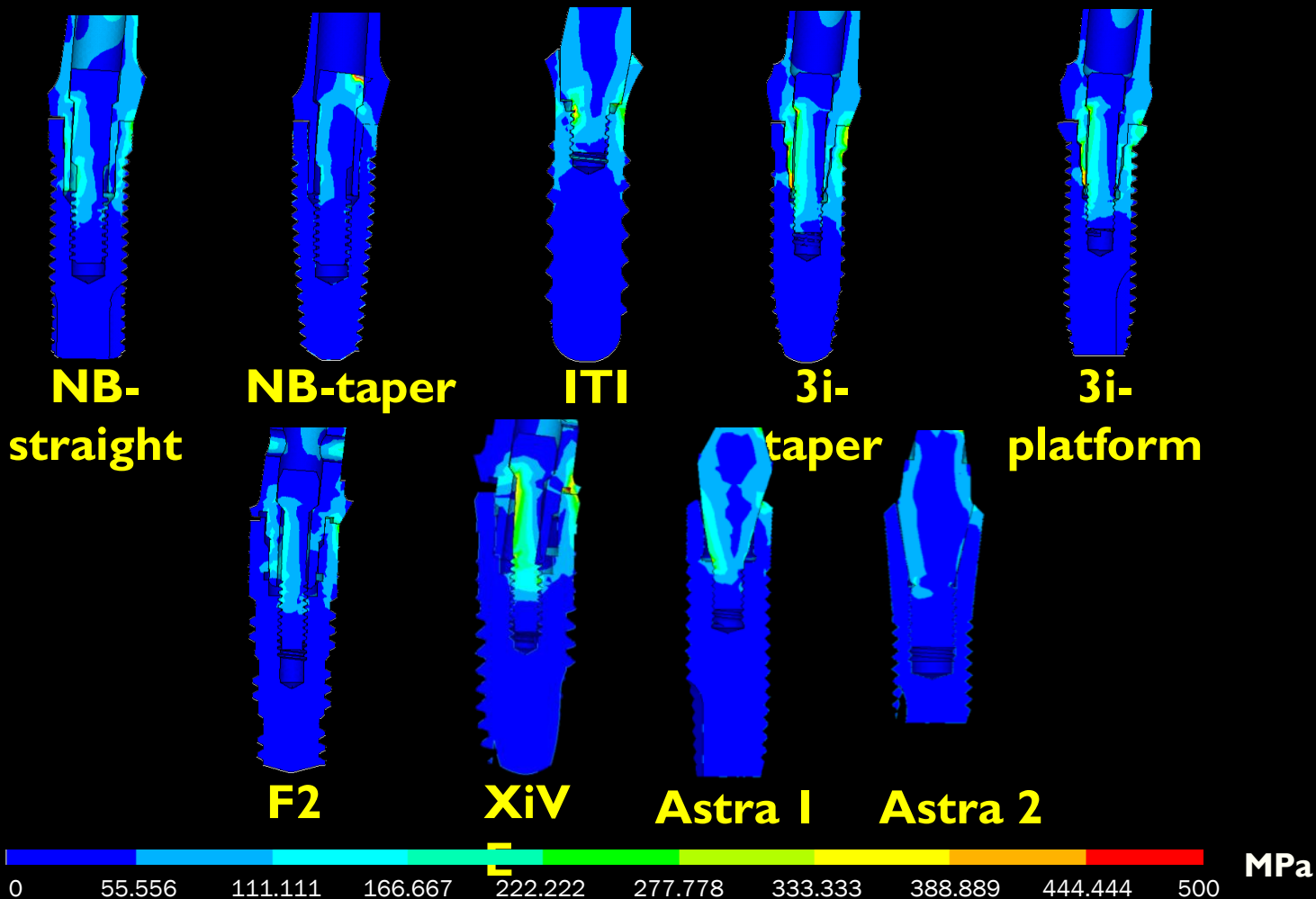

# 有限元素模擬分析結果-側向負載之植體應力值

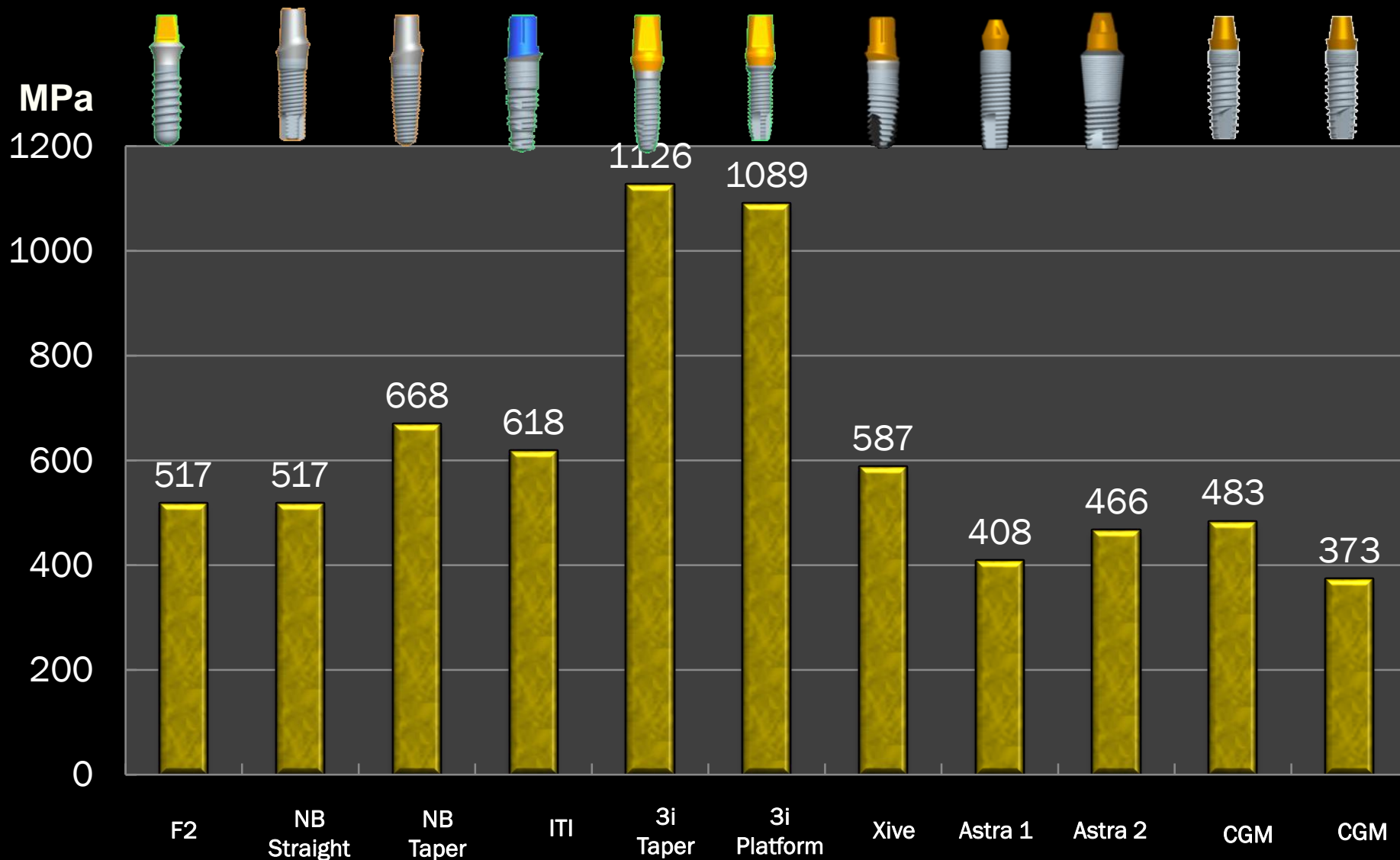

European Journal of Oral Sciences, Vol. 115, pp.408-416, 2007.

# 有限元素模擬分析結果(上顎)

## ●骨質應變分佈圖-側向負載

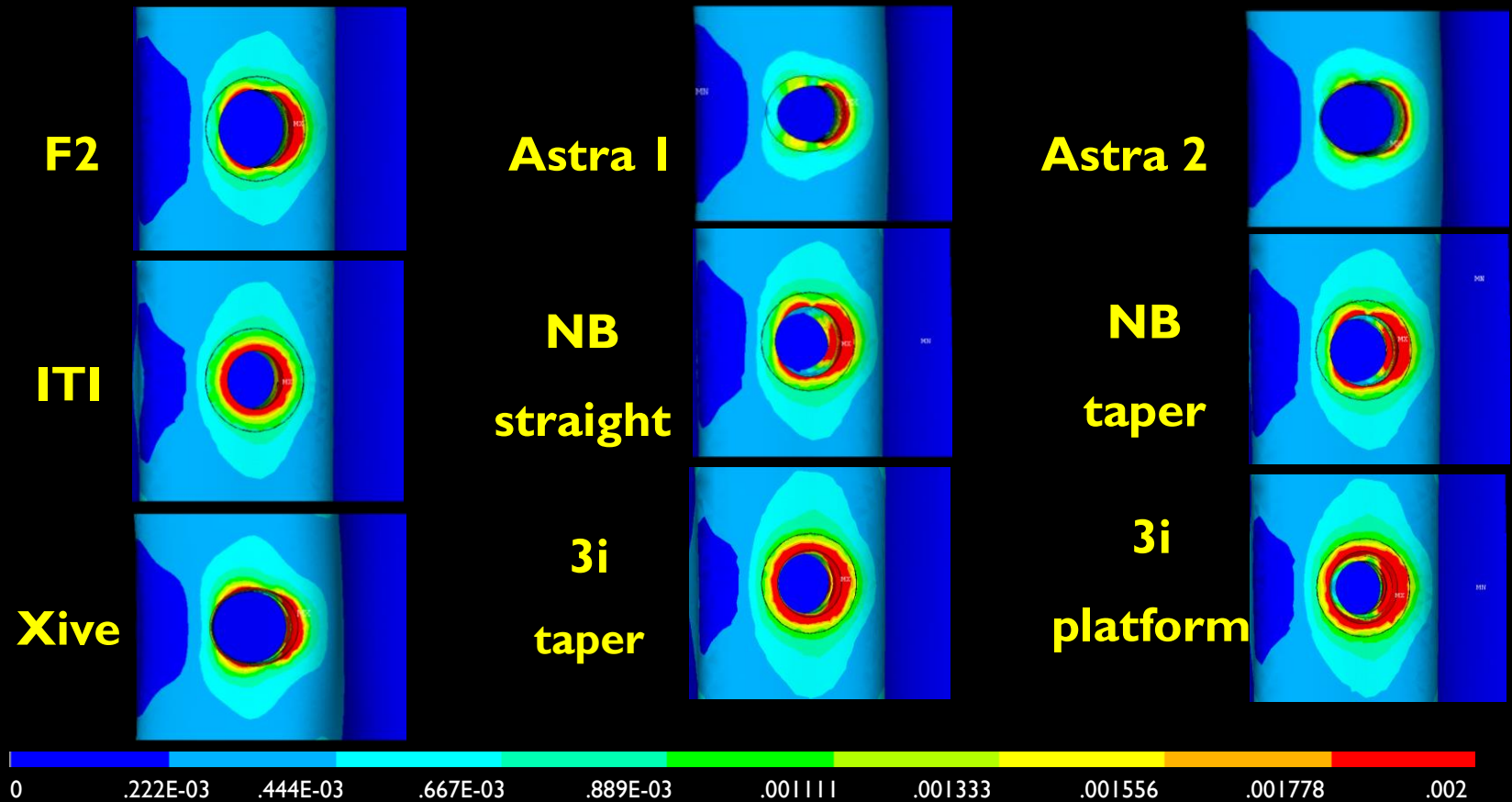

# 有限元素模擬分析結果-側向負載之骨質應變值

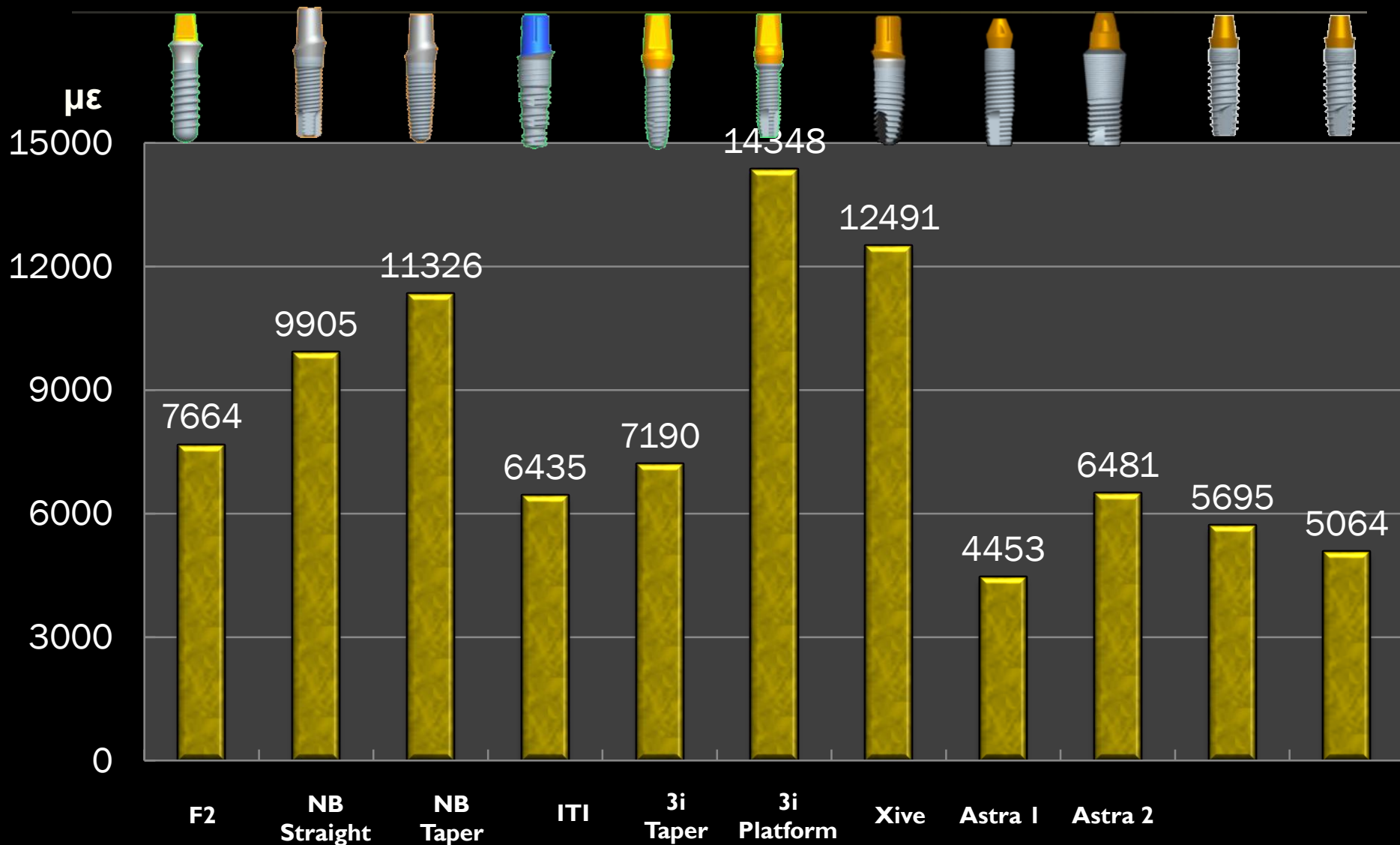

# 產業現況與問題 - 高階醫材(Class II, III)產業缺口與解決方案

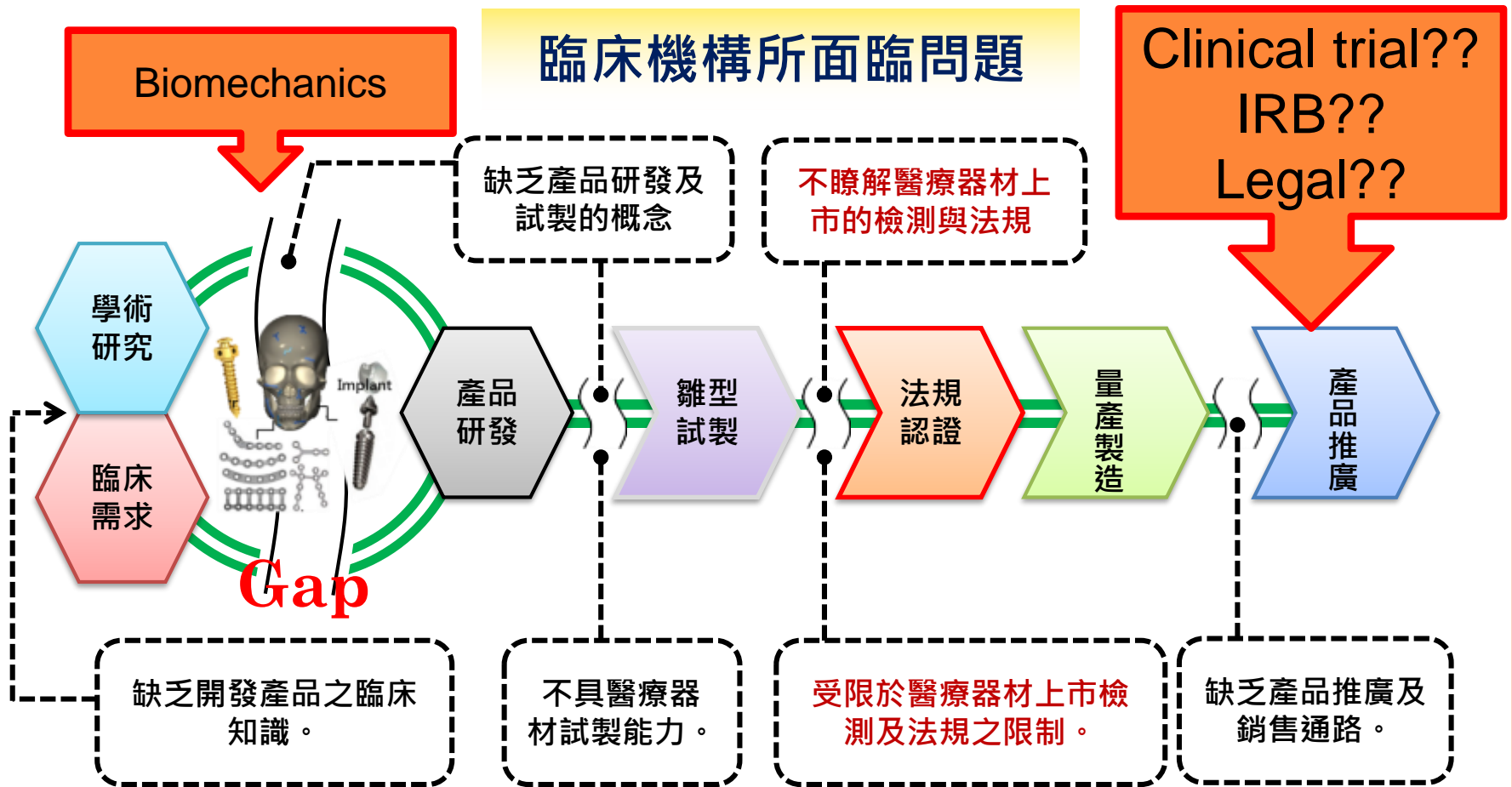

**醫療器材產業所面臨問題**





**Optimal? Biomechanics (CAE/FEA)?**

探討臨床參數不夠多？

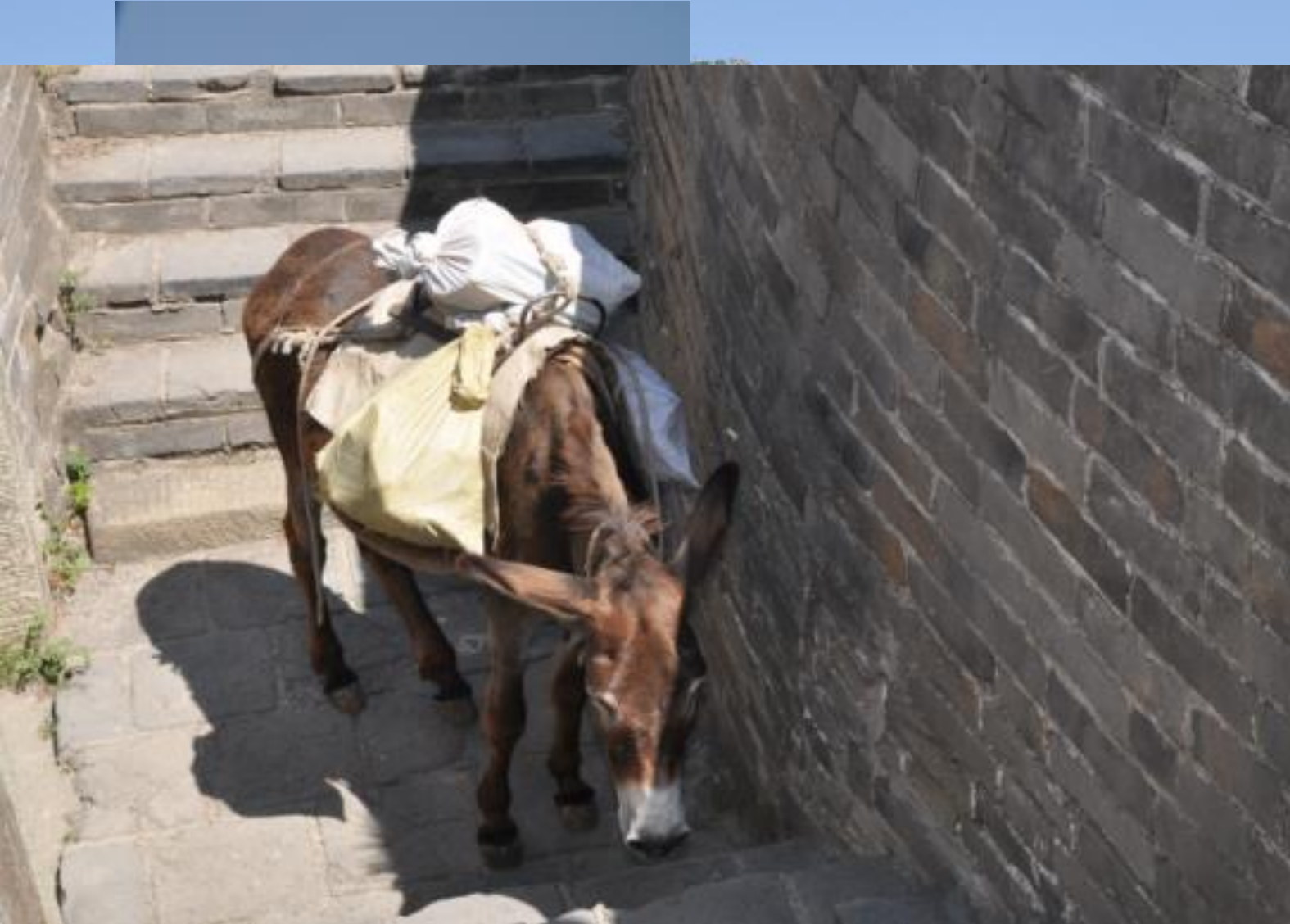

# Moderate/High Risk Medical Devices

★安全有效★



工業用螺絲

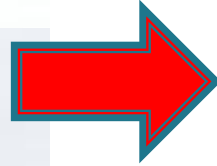

人工牙根

NT0.X→NTX0000

# Dental Implant Approval by FDA

[New Search](#)

[Back To Search Results](#)

**Device Classification Name** [Implant, Endosseous, Root-Form](#)  
**510(K) Number** K122864  
**Device Name** ZUGA DENTAL IMPLANT SYSTEM  
**Original Applicant** ZUGA MEDICAL, INC.  
 P.o. Box 566  
 Chesterland, OH 44028 2141  
**Original Contact** Karen E Warden, Phd  
**Regulation Number** [872.3640](#)  
**Classification Product Code** [DZE](#)  
**Subsequent Product Code** [NHA](#)  
**Date Received** 08/31/2012  
**Decision Date** [04/08/2013](#)  
**Decision** [Substantially Equivalent \(SE\)](#)  
**Classification Advisory Committee** Dental  
**Review Advisory Committee** Dental  
**Summary** [Summary](#)  
**Type** Traditional  
**Reviewed By Third Party** No  
**Expedited Review** No  
**Combination Product** No

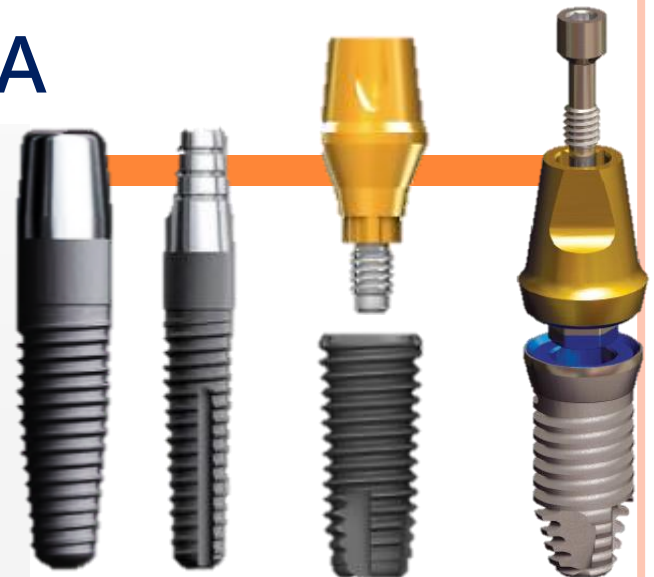

1 piece

2 piece

3 piece

[New Search](#)

[Back To Search Results](#)

**Device** Implant, Endosseous, Root-Form  
**Regulation Description** Endosseous dental implant.  
**Regulation Medical Specialty** Dental  
**Review Panel** Dental  
**Product Code** DZE  
**Submission Type** 510(k)  
**Regulation Number** [872.3640](#)  
**Device Class** 2  
**Total Product Life Cycle (TPLC)** [TPC Product Code Report](#)  
**GMP Exempt?** No

**Recognized Consensus Standards**

- ISO 10993-14 First edition 2001-11-15 [Biological evaluation of medical devices - Part 14: Identification and quantification of degradation products from ceramics](#)
- ISO 14801 Second edition 2007-11-15 [Dentistry-Implants-Dynamic fatigue test for endosseous dental implants](#)
- ISO 7405 Second edition 2008-12-15 [Dentistry - Evaluation of biocompatibility of medical devices used in dentistry](#)
- ASTM F2024-10 [Standard Practice for X-Ray Diffraction Determination of Phase Content of Plasma-Sprayed Hydroxyapatite Coatings](#)
- AAMVANS/ISO 10993-14:2001(R) 2011 [Biological evaluation of medical devices - Part 14:](#)

# Dental Implant Approval by FDA

- Mechanical : ISO 14801
- Biocompatibility : ISO 7405, ISO 10993
- Coating : ASTM F2024-10, ASTM F1377-08
- Forging : ISO 5832-2, ISO 5832-3, ISO 5832-11
- Ceramic : ISO 9693, ISO 10993-14



力學測試



材料測試



塗層及生物相容性測試

# Dental Implant Fatigue Test-ISO14801

- **Purpose** : Life limitation
- **Machine** : Fit ISO 7500-1及 ISO 4965 (accuracy)
- **Setup** :
  - Incline 30 degree
  - Embedding material >3GPa
- **Static test** :
  - Load : 1 min/mm
- **Fatigue test** :
  - 80%,70%,60%,50%,40% of Static fracture load
  - Sine wave
  - Frequency : 15 HZ
  - Cycles : 5,000,000 cycles

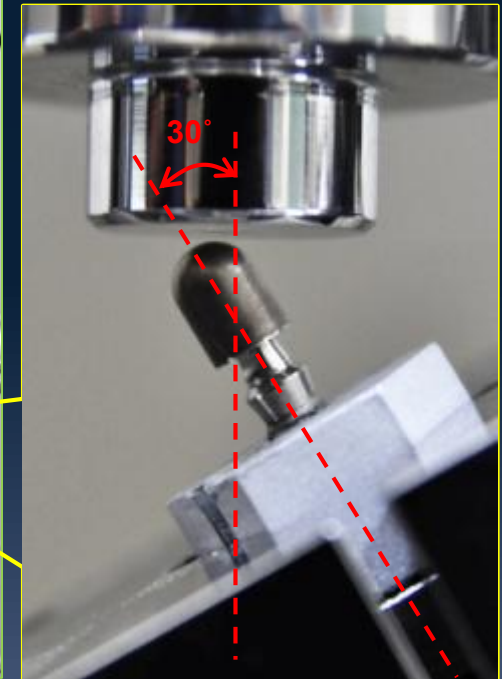

# Dental Implant Fatigue Test-ISO14801

- **Static testing**
  - **Failure load (N)**

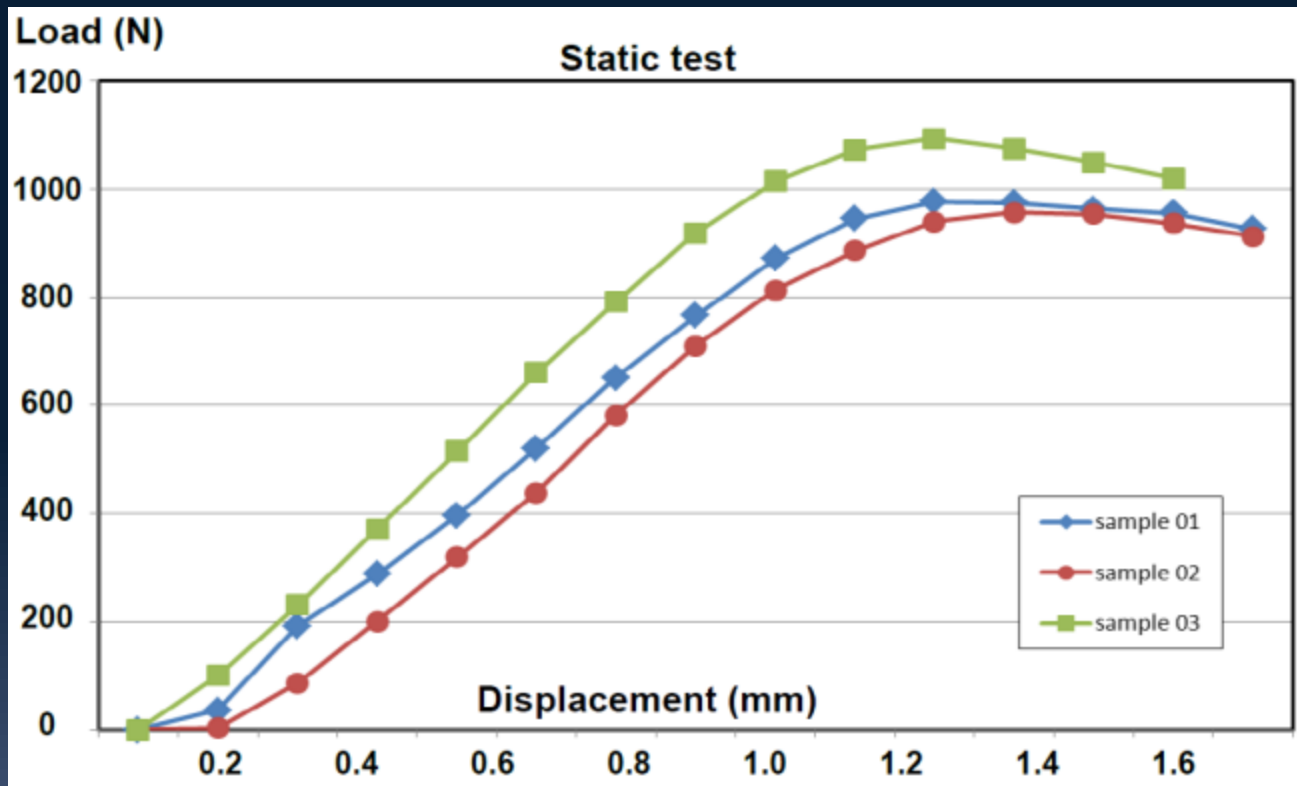

Load-displacement

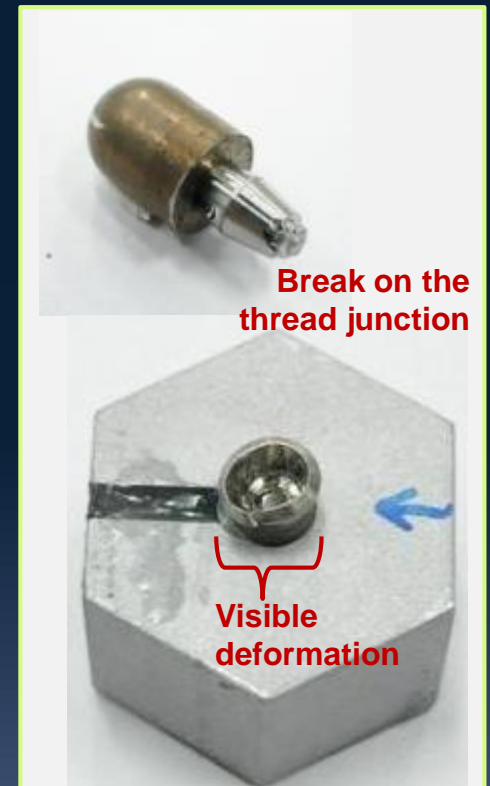

Fracture pattern

# Dental Implant Fatigue Test-ISO14801

% of maximum load	Load /(Moment)	Number of cycles	Temp. / HMD.
80%	Between 80.9N to 809N/ (Between 445Nmm to 4450Nmm )	14309	21°C / 71%
		11156	22°C / 70%
		15765	22°C / 70%
70%	Between 70.8N to 708N/ (Between 389Nmm to 3894Nmm )	24446	22°C / 70%
		27809	22°C / 70%
		22065	22°C / 70%
60%	Between 60.7N to 607N/ (Between 334Nmm to 3339Nmm )	91839	26°C / 61%
		112279	26°C / 59%
		92904	28°C / 57%
50%	Between 50.6N to 506N/ (Between 278Nmm to 2783Nmm )	2987597	28°C / 57.5%
		4188494	27°C / 58%
		2062882	24°C / 60.5%
40%	Between 40.5N to 405N/ (Between 223Nmm to 2228Nmm )	5000000 (pass)	25°C / 68%
		5000000 (pass)	21°C / 58%
		5000000 (pass)	25°C / 58%

# Dental Implant Fatigue Test-ISO14801

- Fatigue testing
  - Life-time figure

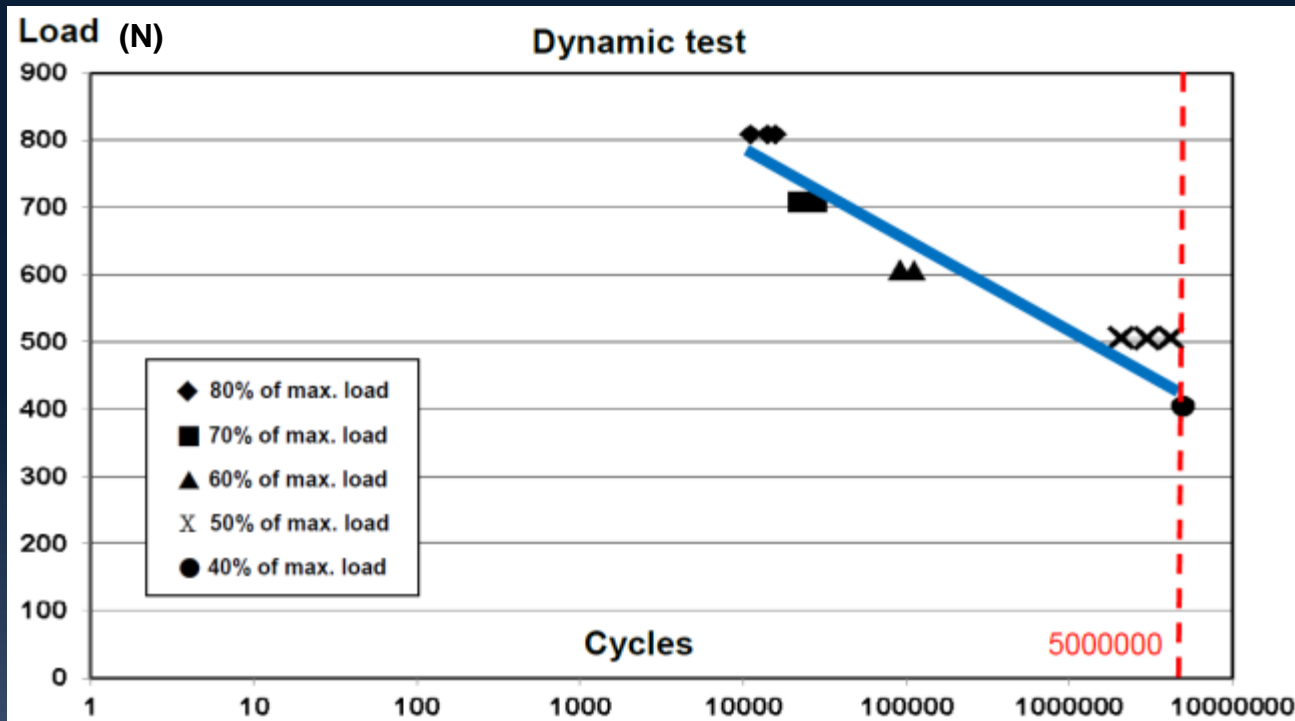

疲勞壽命曲線圖



動態負載後試件

# ISO14801—static test (6 cycles)



第一版

Abutment  
純鈦

Abutment Screw  
純鈦

Fixture  
純鈦



第二版

Abutment  
鈦合金

Abutment Screw  
純鈦

Fixture  
純鈦



第三版

Abutment  
鈦合金

Abutment Screw  
鈦合金

Fixture  
純鈦



第四版

1. fixture長度縮短為9mm

第五版

1. 植體外徑由3.45mm增加至3.6mm。  
2. 粗細螺紋交接處，增加粗螺紋之內徑(即加工時提早收刀)。

第六版

1. 增加abutment腰身厚度20條。  
2. 將abutment/fixture接合向下再深入約1mm (即fixture的morse taper壁側單邊往外擴0.15mm，可將abutment向下移)。

# 3C/3R (CAD/CAM/CAE, RE/RP/RT)

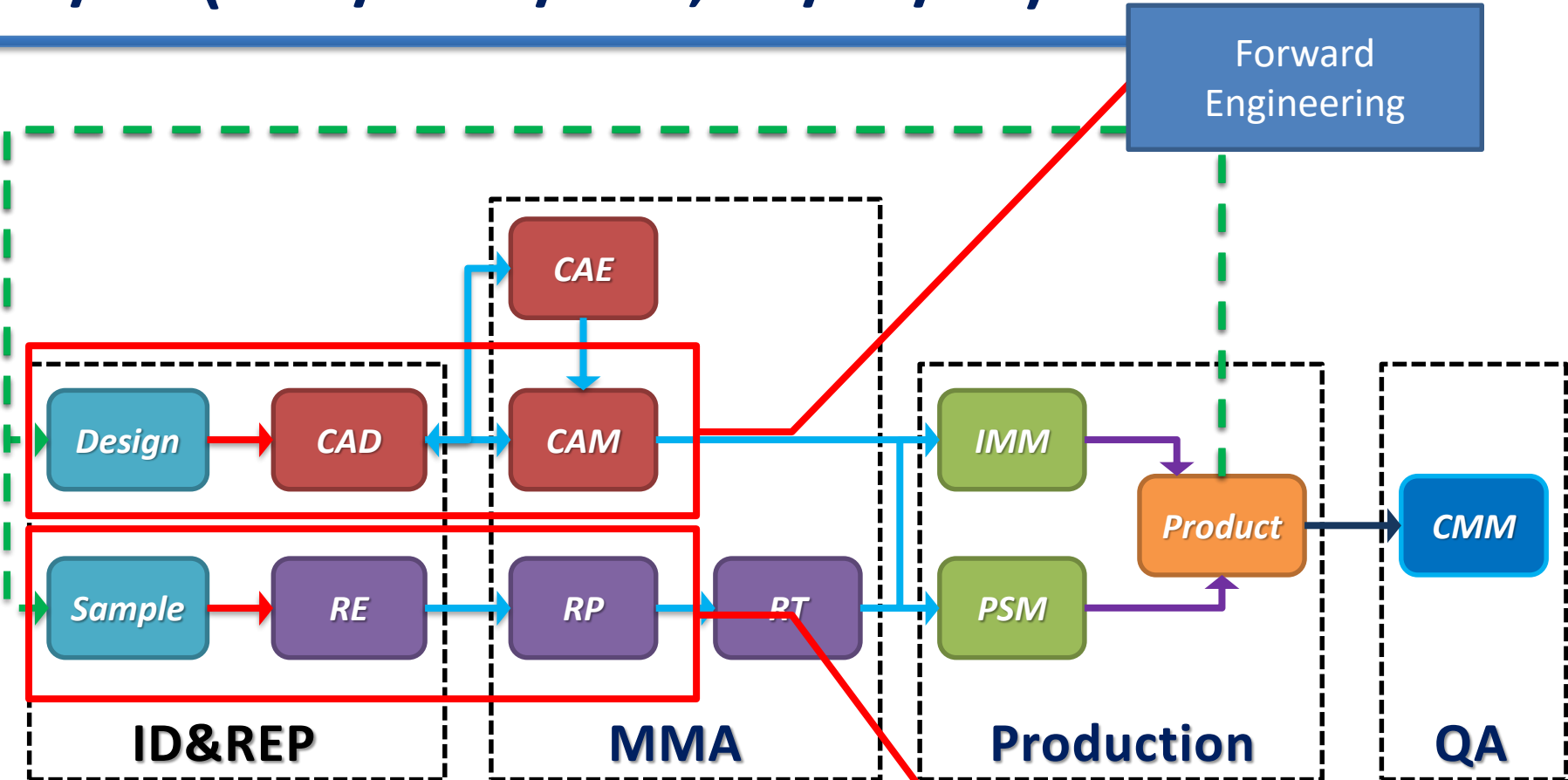

**ID :** Industrial design

**IMM :** Injection mould machine

**QA :** Quality assurance

**MMA :** Mold manufacturing & analysis

**PSM :** Pressing/shearing machine

Reverse Engineering